



1/8-DIN & 1/16-DIN PLASTICS CONTROLLERS

Product Manual

PREFACE

This manual comprises two volumes:

- Volume 1: This supports normal operation of the 1/8-DIN and 1/16-DIN Plastics Controllers. In normal operation, all actions taken by the user are to be in front of the front panel.
- Volume 2: This supports the installation, commissioning and configuring of the 1/8-DIN and 1/16-DIN Plastics Controllers. It is intended for use only by personnel who are trained, equipped and authorised to carry out these functions.

$\frac{1}{8}$ -DIN & $\frac{1}{16}$ -DIN PLASTICS CONTROLLERS

PRODUCT MANUAL

VOLUME 1

OPERATING INSTRUCTIONS

In normal operation, the operator must not remove the Controller from its housing or have unrestricted access to the rear terminals, as this would provide potential contact with hazardous live parts.

Installation and configuration must be undertaken by technically-competent servicing personnel. This is covered in Volume 2 of this manual.

Contents - Volume 1

1	INTRODUCTION	1-1
1.1	TAILORING THE CONTROLLER TO SUIT YOUR NEEDS	1-2
1.2	HOW IT WORKS	1-3
2	OPERATOR MODE	2-1
2.1	INTRODUCTION	2-1
2.2	SELECTING THE PARAMETER TO BE DISPLAYED/ADJUSTED	2-1
2.3	ADJUSTING THE DISPLAYED PARAMETER	2-3
2.4	SOFT START	2-3
2.5	INDICATION OF AN ALARM GOING ACTIVE	2-4
2.6	ALARM STATUS DISPLAY	2-4
2.7	OVER-RANGE/UNDER-RANGE DISPLAYS	2-4
2.8	SENSOR BREAK INDICATION	2-5
2.9	OUTPUT TURN OFF	2-5

2.10	MANUAL CONTROL MODE	2-5
2.11	HEATER CURRENT DISPLAY	2-5
2.12	SOFT START IN PROGRESS	2-6
2.13	QUICK TRANSFER OF HEATER CURRENT TO NOMINAL VALUE	2-6
2.14	PRE-TUNE	2-7
2.15	SELF-TUNE	2-7
2.16	TO VIEW THE HARDWARE DEFINITION CODE	2-8
3	SET UP MODE	3-1
3.1	ENTRY INTO SET UP MODE	3-1
3.2	SET UP MODE PARAMETERS	3-2
3.3	OPERATOR MODE DISPLAYS	3-17
3.4	TUNING THE CONTROLLER MANUALLY	3-18
3.5	SELF-TUNE	3-19
3.6	EXIT FROM SET UP MODE	3-20
4	MODBUS RTU COMMUNICATIONS	4-1
4.1	COMMUNICATIONS WRITE ENABLE/DISABLE	4-1
4.2	PHYSICAL REQUIREMENTS	4-1
4.3	MODBUS RTU PROTOCOL	4-1
4.4	INDIVIDUAL PARAMETERS	4-9
5	ASCII COMMUNICATIONS	5-1
5.1	COMMUNICATIONS WRITE ENABLE/DISABLE	5-1
5.2	PHYSICAL REQUIREMENTS	5-1
5.3	INDIVIDUAL PARAMETERS	5-7
5.4	ERROR RESPONSE	5-15

1 INTRODUCTION

The $\frac{1}{16}$ -DIN and $\frac{1}{8}$ -DIN Plastics Controllers are economical, microprocessor-based temperature controller specially designed for use in plastics applications. They incorporate the latest in surface-mount and CMOS technology. The standard features include:

Dual four-digit LED display (upper display red, lower display green).

Thermocouple or three-wire RTD sensor input

Relay, SSR drive (10V) or solid state Output 1.

Input range selected from the front panel.

Heater current "ammeter" on front panel. Can use a unique two-wire "SCRi" connection to dedicated silicon controlled rectifier stacks. Also supports standard four-wire connection via a separate current transformer.

Heater Break alarms (high, low and short-circuit) to cater for most requirements.

Unique "Quick Transfer" for easy set up of heater break alarms. This can be initiated from the front panel, digital input or via the communications link

Soft Start with dedicated setpoint, timer and Output 1 power limit.

Adjustable alarm hysteresis.

90 - 264V AC power supply.

Certified to EN50081-1:1992 and EN50081-2:1994 (Emission) and to EN50082-1:1992 and EN50082-2:1995 (Immunity) EMC specifications. Complies with EN61010-1:1993 Safety Standard.

Front panel sealing to IP66 (NEMA 4) standard.

CE rated (UL pending).

Auto/Manual Control and Auto/Zero Power

Pre-Tune and Self-Tune.

Setpoint ramping.

Programmable input filter.

Alarm type selected from front panel.

Sensor Break protection.

Setpoint maximum and minimum limits (user-defined).

and its many optional features include:

MODBUS and ASCII (selectable) communications with up to 128 zone address capability.

Output 2 - secondary (COOL) control output (relay, SSR drive or solid state), Alarm 2 output, Heater Break alarm output or logical combination of Alarm 1 and Alarm 2.

Output 3 - Alarm 1 output, Heater Break Alarm output, DC recorder output (setpoint or process variable) or logical combination of Alarm 1 and Alarm 2.

Output 4 - Heater Break Alarm output.

Dual setpoint, remotely selectable.

NOTE: The communications option and the dual setpoint/quick transfer option are mutually exclusive.

1.1 TAILORING THE CONTROLLER TO SUIT YOUR NEEDS

The Controller has three modes in which adjustments can be made via the front panel keys:

Configuration Mode: This is normally used only when the Controller is first configured or when a major change is to be made to the Controller characteristics. Entry into this Mode is security-protected. The Configuration Mode parameters should be set as required before any other adjustments are made. Changing Configuration Mode parameters invariably sets other parameters to their default values. Adjustments to these parameters should be performed only by personnel competent and authorised to do so.

Set Up Mode: This mode is used when a change to the process set-up is required. The frequency of use for this mode is dependent upon the process being controlled. This mode also determines the scope of adjustments available in Operator Mode (see below). Access to this mode is via a user-defined password.

Operator Mode: This is the mode for day-to-day use. The parameters in this mode are freely available to the operator. The adjustment facilities available in this mode are dependent upon the settings of parameters in the Set Up Mode.

1.2 HOW IT WORKS

The Plastics Controller is tailored towards plastics applications. The function of the Controller is best described in terms of the control it exercises over the process and the use of its alarms.

1.2.1 Control

The temperature at which the process must operate is called the setpoint (SP). The actual process temperature which is being measured and controlled is called the process variable (PV). Thus, if the setpoint is adjusted to 200°C, the Controller endeavours to maintain the process variable at 200°C.

PID control (also known as three-term control) is a well-proven and widely-used method for high accuracy automatic control. Best results are obtained when the Controller is correctly tuned - easily achieved by just letting the Controller tune itself to your process, using the automatic tuning features.

Heater current is controlled via Output 1. Although the heater can only be either fully-on or fully-off, the process reacts only to the average power, assuming heater on-off periods are sufficiently brief. The PID algorithm can control average power very accurately, thereby ensuring smooth and accurate control of the process. This method of controlling output power is very common and is known as time-proportioning. An adjustable Cycle Time parameter determines the duration of each on-off output cycle. Longer cycle times prolong mechanical relay contact life; shorter cycle times (normally using solid state relays) will be needed on processes which react more quickly. Output 2 can be used as a cooling output, if required.

The Controller has a special Soft Start feature, used when a gentle start-up phase is required in order to avoid damage to the process. An adjustable Soft Start Setpoint is used by the Controller during a Soft Start. The duration of the Soft Start phase is determined by an adjustable Soft Start Time parameter. During this phase, Output 1 power is kept within an adjustable limit and the Output 1 cycle time is reduced to a quarter of its normal value (but never less than 0.5 seconds) to reduce further the risk of thermal shock to the process.

The Controller can be put into Manual Control if selected by the operator. In this mode, the operator adjusts manually the Controller's output power. When switching between automatic control and manual control, the Controller minimises any sudden power changes; this is known as a "bumpless transfer" and avoids thermal shocks to the process. Manual Control mode can be configured to be a non-adjustable zero power value or disabled completely.

1.2.2 Alarms

Alarms allow early warning (and automatic corrective action, if necessary) in the event of abnormal process conditions - heater failure, sensor failure, human error etc. In addition to giving visual indication of such conditions, alarms can be connected to outputs; the Controller can intervene automatically as soon as it detects a problem in the plant.

Two standard alarms are provided which warn if the process variable temperature moves outside prescribed limits. These alarms can be set to react if the process variable goes above or below specific temperatures or moves too far away from the setpoint. In the latter case, the alarm settings need no re-adjustment if the setpoint is changed.

Heater break alarms allow prompt detection of heater failure, minimising the risk of damage to the process. Three different types of alarm are provided, permitting the majority of heater failures to be handled effectively. The actual heater current can be displayed on the front panel.

2 OPERATOR MODE

2.1 INTRODUCTION

This Section covers the routine operation of the Controller, once it has been installed and configured. The Controller front panel indicators and keys are shown in Figure 2-1.

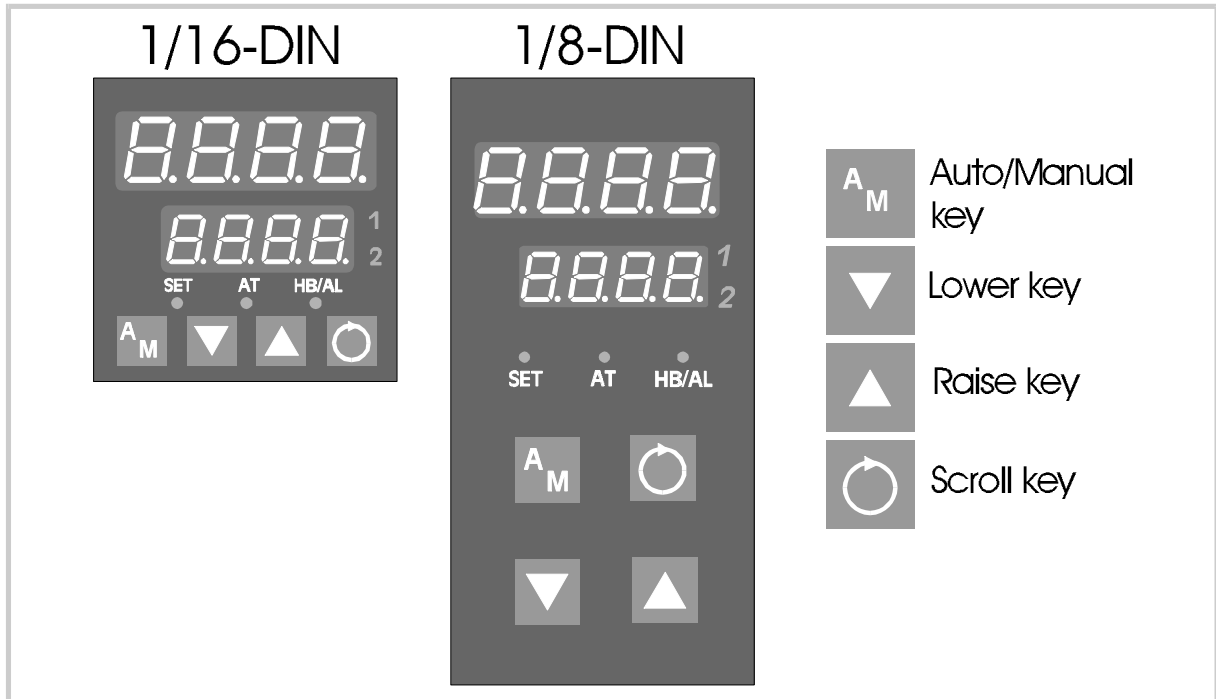
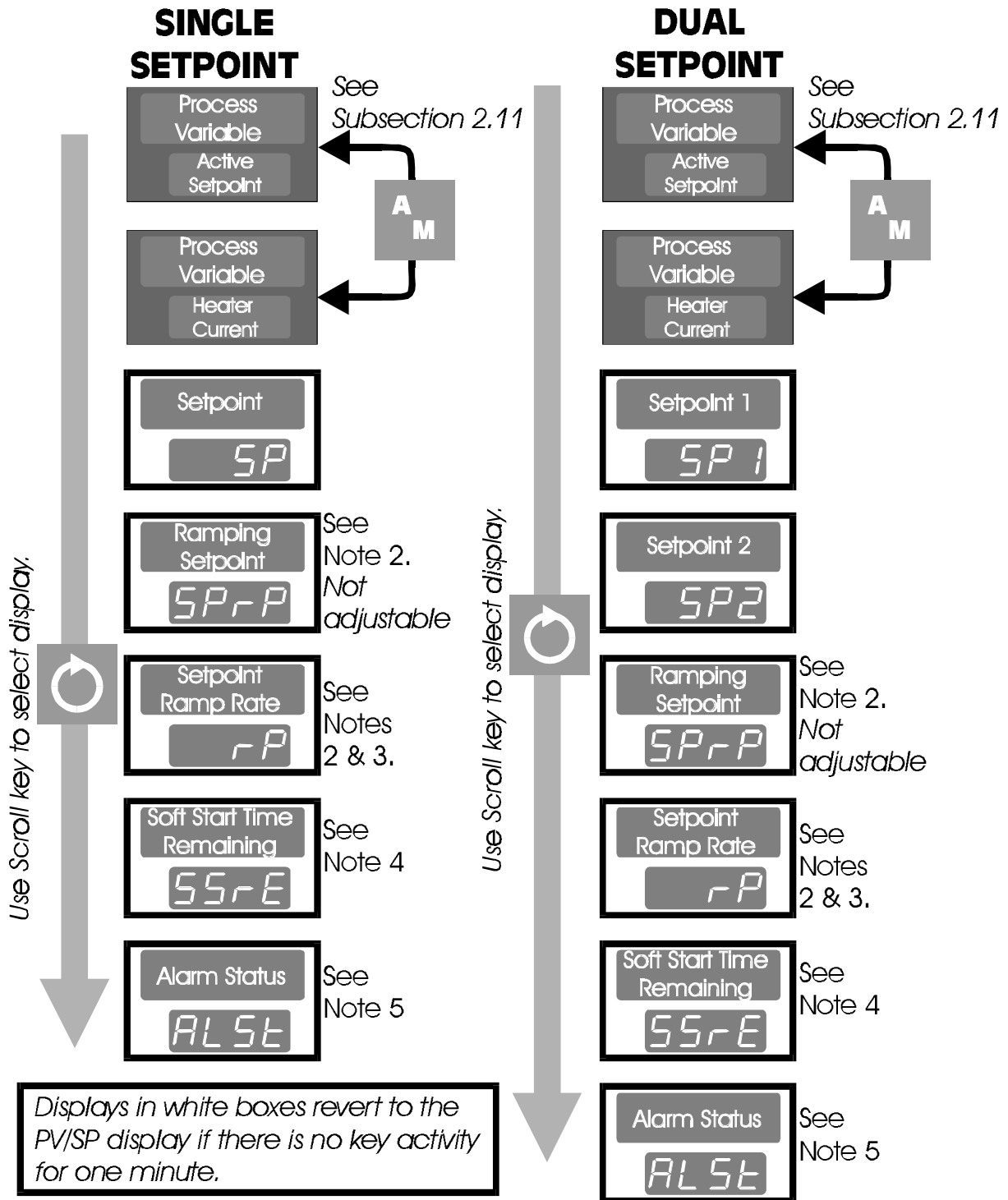

Figure 2-1 Front Panel Indicators and Control Keys

2.2 SELECTING THE PARAMETER TO BE DISPLAYED/ADJUSTED

After the Controller has performed its power-up self-test, the initial displays appear. The Scroll key may then be used to step through the available displays. These displays are dependent upon whether the Controller has been configured for Single Setpoint operation or Dual Setpoint operation (see overleaf).



NOTES

1. Setpoint is not adjustable if Setpoint Strategy = 1 (see Subsection 3.2.40) but is adjustable if Setpoint Strategy = 2. Active setpoint is one of: Setpoint, Setpoint 1, Setpoint 2 or Soft Start Setpoint, as appropriate.
2. Appears only if setpoint ramping is enabled and ramp rate is in the range 1 - 9999.
3. Ramp rate is adjustable in the range 1 - 9999 (On) and Off (blank).

NOTES (continued)

- 4. Only appears if a Soft Start is in progress; see Subsection 2.4.
- 5. Appears only if an alarm is active; see Subsection 2.6.
- 6. In dual setpoint operation, the lower display distinguishes between the active and inactive setpoints in the following manner:

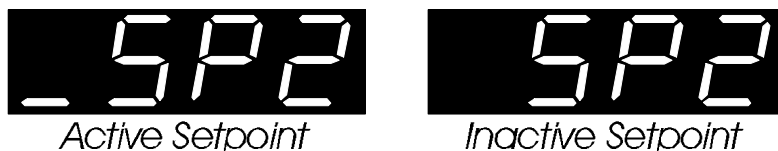

2.3 ADJUSTING THE DISPLAYED PARAMETER



If either of these keys is held down for 10 seconds or more, the adjustment rate changes to “high speed” mode.

2.4 SOFT START

Soft Start is used when a gentle start-up phase is required, before going to full working temperature. During Soft Start, a dedicated setpoint is used to control the process to a lower temperature than normal. A power limit can be applied to Output 1 during Soft Start, constraining the average Output 1 power. During Soft Start, the Output 1 cycle time is automatically reduced to give added protection against thermal shock (NOTE: because of the nature of time-proportioned outputs, Output 1 will still be fully-on for part of each output cycle).

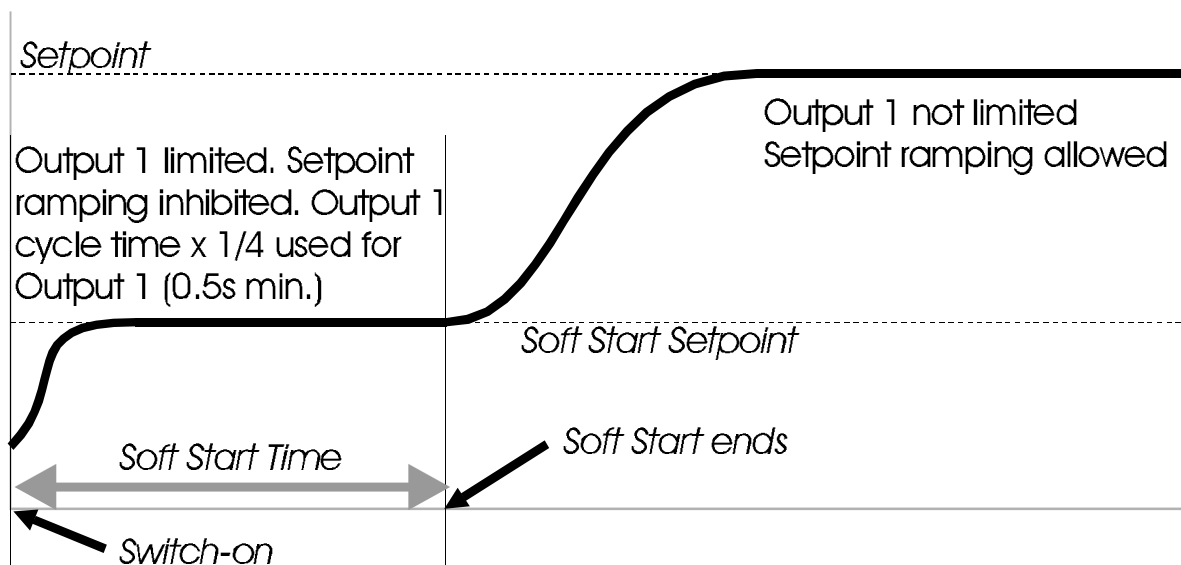

Soft Start Time, Soft Start Setpoint and power limit are all adjustable in Set Up Mode (see Section 3). Soft Start is aborted at start-up if the process variable exceeds the Soft Start Setpoint. Setpoint ramping is inhibited during Soft Start. During a Soft Start, the Soft Start time remaining at any moment may be read from the front panel.

2.5 INDICATION OF AN ALARM GOING ACTIVE

If any of the Heater Break Alarms (High, Low or Short Circuit), Alarm 1 or Alarm 2 goes active, the **HB/AL** indicator will flash.

2.6 ALARM STATUS DISPLAY (available if one or more alarms are active)

The alarm status display is in the following format:

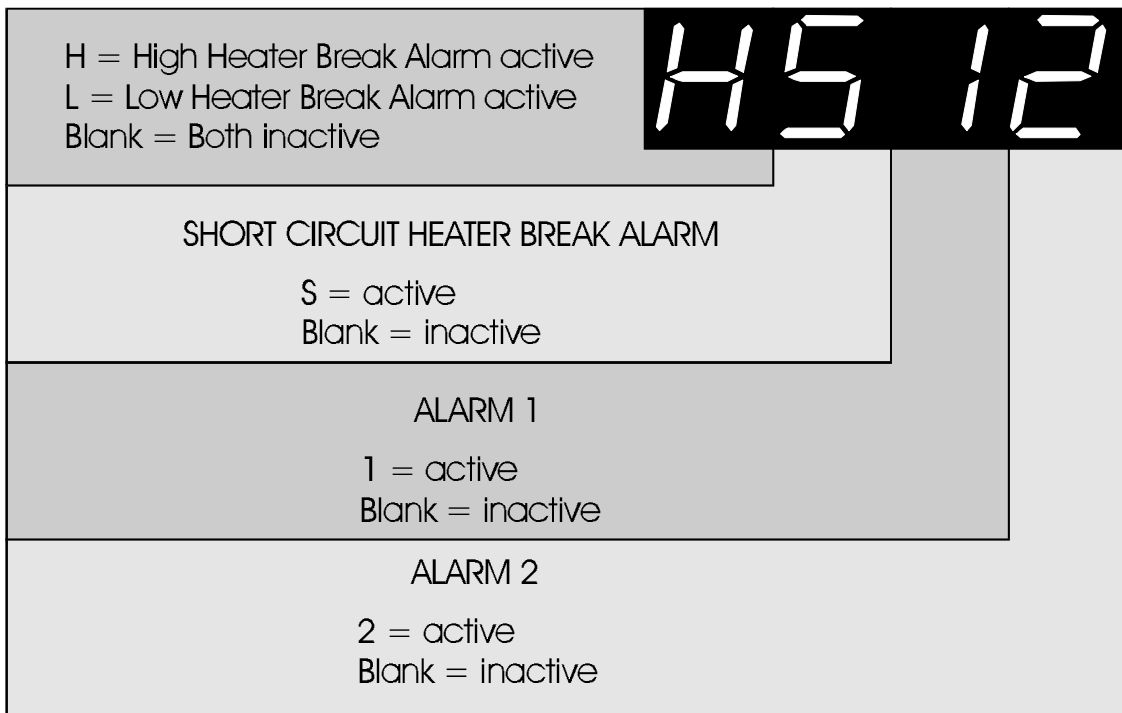

2.7 OVER-RANGE/UNDER-RANGE DISPLAYS

If the process variable goes under-range or over-range, the upper display will show the appropriate one of:

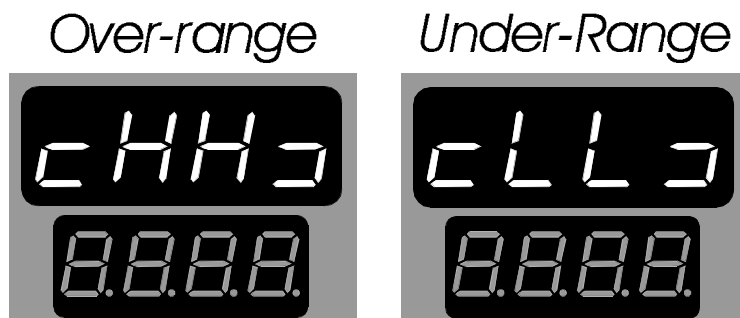

2.8 SENSOR BREAK INDICATION

If a break is detected in the sensor circuit, the upper display will show:



The reaction of the outputs and alarms to a detected sensor break is dependent upon the input type.

2.9 OUTPUT TURN OFF

(AM Key Usage Set Up parameter = )

Press the **AM** key to switch between automatic control and the control output(s) being permanently turned off. A return to automatic control is via a bumpless transfer. The **SET** indicator flashing pattern will be mostly OFF (if in Operator Mode) or mostly ON (if in Set Up Mode).

2.10 MANUAL CONTROL MODE

(AM Key Usage Set Up parameter = )

Press the **AM** key to switch between manual control and automatic control. In manual control, the output power is displayed and may be adjusted. The **SET** indicator flashing pattern will be mostly OFF (if in Operator Mode) or mostly ON (if in Set Up Mode).

Transfer between automatic control and manual control is bumpless in both directions.

2.11 HEATER CURRENT DISPLAY

(AM Key Usage Set Up parameter = )

Press the **AM** key to display quickly the process variable/heater current, *regardless of the original display*. The heater current display is in the format:



Press the **AM** key again to display the process variable/setpoint (i.e. the first Operator Mode display). Subsequent **AM** key presses will switch between these two displays.

2.12 SOFT START IN PROGRESS

If a Soft Start is in progress, the heater current display will show (in the lower display):



The normal heater current display will be restored as soon as the Soft Start time has expired.

2.13 QUICK TRANSFER OF HEATER CURRENT TO NOMINAL VALUE

The nominal value of the heater current is manually adjustable in Set Up Mode. However, to set the nominal value to the prevailing heater current value in Operator Mode:

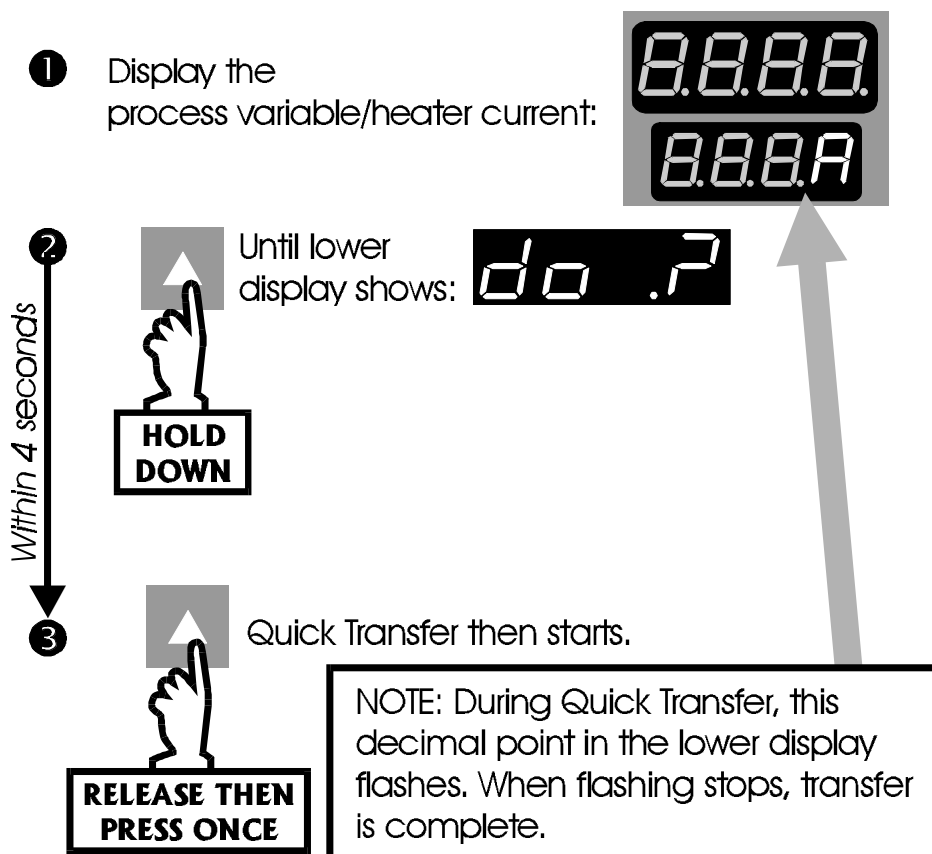

2.14 PRE-TUNE

To tune approximately the Controller's PID parameters, activate Pre-Tune:

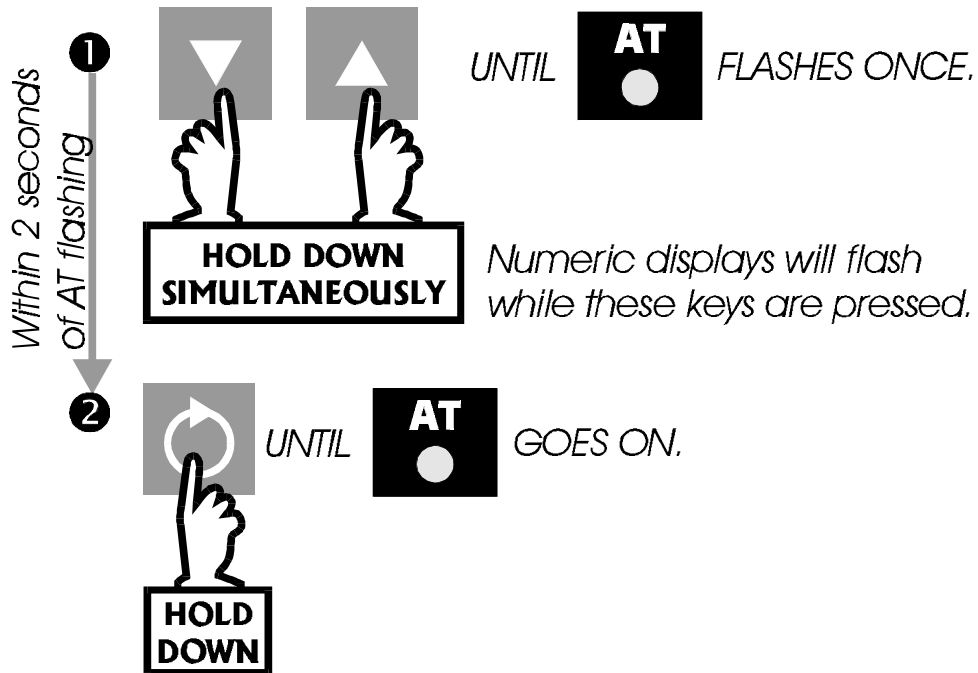

The AT indicator will flash whilst Pre-Tune is operating. To dis-engage Pre-Tune, repeat this procedure (the AT indicator will go OFF).

2.15 SELF-TUNE

To optimise tuning whilst the Controller is operating, activate Self-Tune:

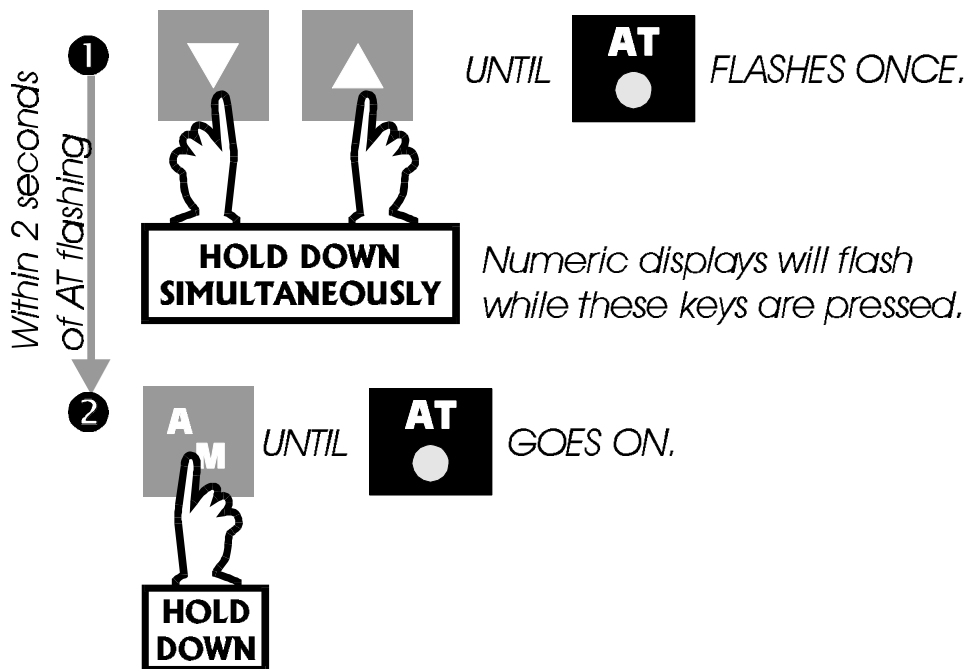

To dis-engage Self-Tune, repeat this procedure (the AT indicator will go OFF).

2.16 TO VIEW THE HARDWARE DEFINITION CODE

The Hardware Definition Code indicates the input type and output type(s) fitted (see below). To view this Code:

After the Controller has been powered-up for at least 30 seconds:

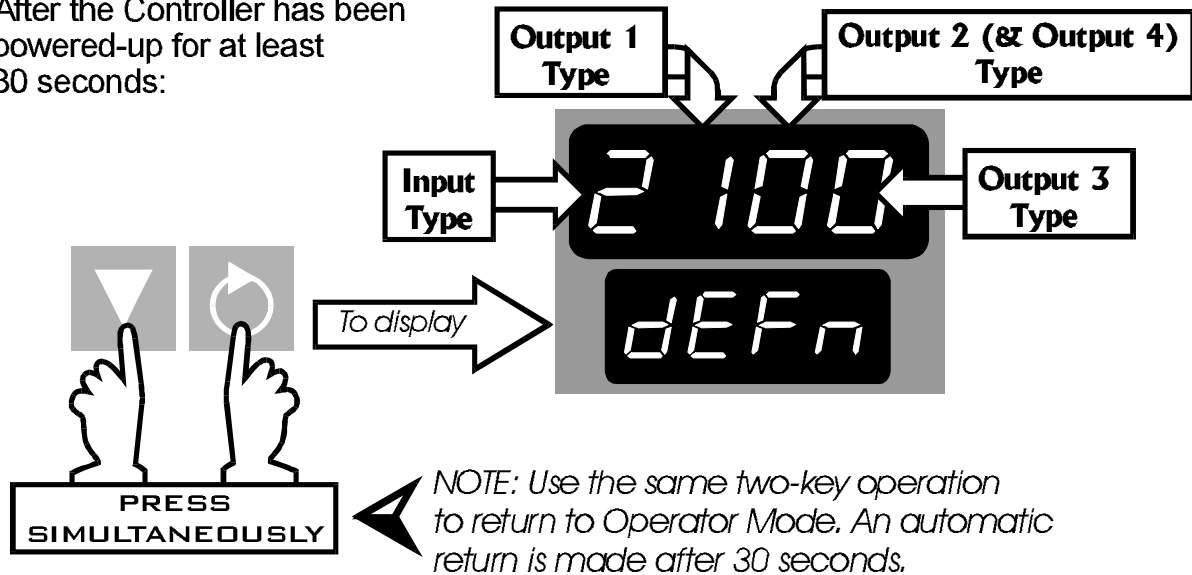

The same key action causes a return to the normal Operator Mode display. An automatic return is made to the normal Operator Mode display after 30 seconds. The Hardware Definition Code has the following significance:

Value	0	1	2	3	4	5	7	8	9
Input		RTD Input	Thermo-couple Input						
Output 1		Relay Output	SSR Drive Output					Solid State Output	
Output 2(& 4)	Not fitted	Relay Output 2	SSR Drive Output 2					Solid State Output 2	Relay Output 2 & 4 *
Output 3	Not fitted	Relay Output		DC 0-10V Output	DC 0-20mA Output	DC 0-5V Output	DC 4-20mA Output	Solid State Output	

* Dual Relay Option PCB must be fitted

3 SET UP MODE

3.1 ENTRY INTO SET UP MODE

1 Put Controller in Operator Mode with normal display.

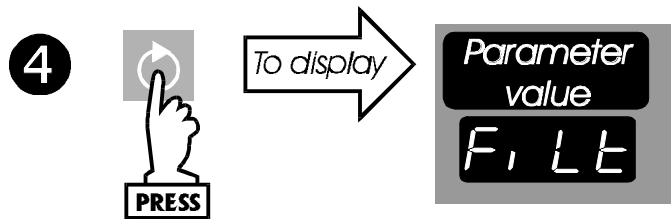
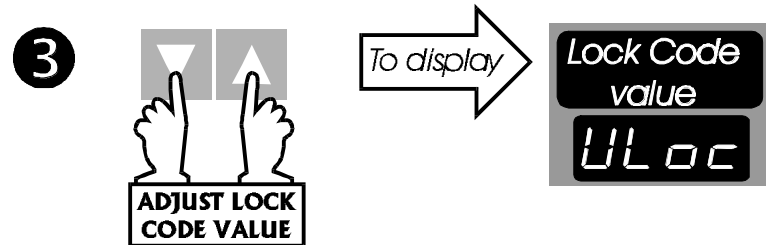
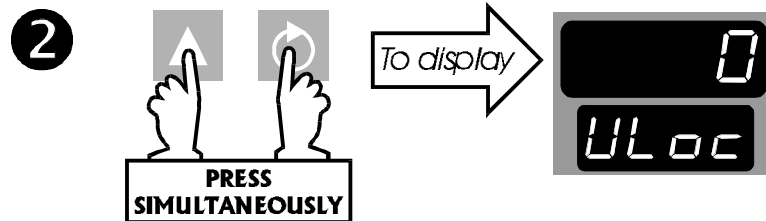

If the upper display does not show the correct Lock Code value when this key is pressed, a return is made to the original Operator Mode display.

NOTE: If the upper display shows:



(i.e. all decimal point positions ON), parameters are at their default values, possibly due to a change in Controller configuration. To cancel this indication, adjust any Set Up Mode parameter (see below). It is recommended that all configuration parameters are finalised before any adjustments are made to Set Up Mode parameters.

3.2 SET UP MODE PARAMETERS

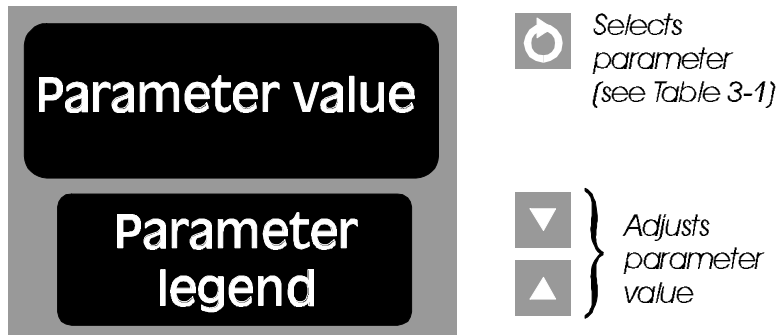

Table 3-1 Set Up Parameters

Parameter	Legend	Adjustment Range	Default
Input Filter Time Constant	F,LT	OFF, 0.5s to 100.0s In 0.5s increments	2.0s
Process Variable Offset	OFFS	±input span of Controller	0
Output Power	Out 1	0 to 100%	Read Only
Output Power 2 ⁴	Out 2	0 to 100%	Read Only
Proportional Band 1	Pb 1	0.0% to 999.9% of input span	10.0%
Proportional Band 2 ^{1,4}	Pb 2	0.0% to 999.9% of input span	10.0%
Reset (Integral Time Constant) ¹	rSET	1s to 99m 59s and OFF.	5m 00s
Rate (Derivative Time Constant) ¹	rATE	00s to 99m 59s	1m 15s
Overlap/Deadband ^{1,4}	OL	-20% to + 20% of Proportional Band 1 + Proportional Band 2	0%
Manual Reset (Bias) ¹	b,AS	0% to 100% (single output) -100% to +100% (dual output)	25%
ON/OFF Differential ² : Output 1 only	d, F 1	0.1% to 10% of input span	0.5%
Output 2 only ⁴	d, F 2		
Outputs 1 & 2 ⁴	d, FF		
Setpoint High Limit	SPH	Setpoint to Range Max.	Range Max.
Setpoint Low Limit	SPL	Range Min. To Setpoint	Range Min.

Table 3-1 (Cont.) Set Up Parameters

Parameter	Legend	Adjustment Range	Default
Recorder Output Scale Max.	r_oPH	-1999 to 9999	Range Max.
Recorder Output Scale Min.	r_oPL	-1999 to 9999	Range Min.
Output 1 Power Limit ¹	OPH1	0 to 100% of full power	100%
Output 1 Cycle Time	CT1	0.5, 1, 2, 4, 8, 16, 32, 64, 128, 256 or 512 seconds	32seconds
Output 2 Cycle Time	CT2	0.5, 1, 2, 4, 8, 16, 32, 64, 128, 256 or 512 seconds	32seconds
Process High Alarm 1 value ³	h_A1	Range Min. To Range Max.	Range Max.
Process Low Alarm 1 value ³	L_A1	Range Min. To Range Max.	Range Min.
Band Alarm 1 value ³	b_A1	0 to span from Setpoint	5 units
Deviation Alarm 1 value ³	d_A1	±span from Setpoint	5 units
Alarm 1 Hysteresis	AHY1	1 - 250 units	1 unit
Process High Alarm 2 value ³	h_A2	Range Min. To Range Max.	Range Max.
Process Low Alarm 2 value ³	L_A2	Range Min. To Range Max.	Range Min.
Band Alarm 2 value ³	b_A2	0 to span from Setpoint	5 units
Deviation Alarm 2 value ³	d_A2	±span from Setpoint	5 units
Alarm 2 Hysteresis	AHY2	1 - 250 units	1 unit
Heater Current High Scale Limit	hcrH	10.0A to 20.0A in 0.1A steps 21A to 100A in 1A steps	50A
Heater Current Nominal ⁹	hcrN	0 to Heater Current High Scale Limit	High Scale Limit
Low Heater Break Alarm level (% or amount below nominal heater current)	L_hb	1% to 100% (of nominal) and 0 (OFF) or 0.1A/1A to Heater Current High Scale Limit	20% or 0 (OFF)

Table 3-1 (Cont.) Set Up Parameters

Parameter	Legend	Adjustment Range	Default
High Heater Break Alarm level (% or amount above nominal heater current)	h_hb	1% to 100% (of nominal) and 0 (OFF) or 0.1A/1A to Heater Current High Scale Limit	0 (OFF)
Short Circuit Heater Break Alarm ¹⁰	S_hb	0 (disabled) or 1 (enabled)	1 (enabled)
Soft Start Setpoint	SSSP	Range Min. To Range Max.	Range Min.
Soft Start Time	SSe	15s to 59m 45s and 0 (OFF) in 15-second increments	0 (OFF)
Auto Pre-Tune Enable/Disable	APt	0 (disabled) or 1 (enabled)	0 (disabled)
AM Key Usage	butn	0oFF Output Turn-off PoEn Manual Control htrA Heater Current display/Manual Control Disable	
SP Ramping Enable/Disable	rPEn	0 (disabled) or 1 (enabled)	0 (disabled)
Comms. Write Enable/Disable ⁶	CoEn	0 (disabled) or 1 (enabled)	1 (enabled)
Setpoint Strategy	SPSt	1 or 2	1
Lock Value	Loc	0 to 9999	10
OPERATOR MODE DISPLAYS (still accessible in Set Up Mode)			
PV/Active SP		See Subsection 2.2	-
PV/Heater Current		Read Only	-
SP or SP1 ⁸	SP SP1	SPHi to SPLo	SPLo
SP2 (Dual SP only)	SP2	SPHi to SPLo	SPLo
Ramping SP value ⁵	SPrP	Read Only	-
SP Ramp Rate ⁷	rP	1 to 9999 and OFF	OFF
Soft Start Time Remaining	SSrE	Read Only	-
Alarm Status	ALSt	Read Only (see Subsection 2.6)	-

NOTES ON TABLE 3-1

1. These parameters are not operative if the Proportional Band = 0.
2. Switching differential with ON/OFF Control Output.
3. These parameters are optional; only one legend will appear for each alarm.
4. Only applicable if Output 2 is fitted.
5. Appears only if ramp rate **rp** is not switched OFF.
6. Applicable only if the Communications Option PCB is fitted.
7. Does not appear in Operator Mode unless **rPEN** = 1.
8. For Single Setpoint operation, the legend displayed is **SP**; for Dual Setpoint operation, the legend displayed is **SP1**.
9. Applicable only when Heater Break Alarm Strategy is configured to Percentage Mode.
10. Does not appear if Heater Break Input Type is configured to be SCRI.

3.2.1 Input Filter Time Constant

The Controller input is equipped with a digital filter which is used to filter out any extraneous impulses on the process variable. This filtered PV is used for all PV-dependent functions (control, alarms etc.). The time constant for this filter may be adjusted in the range 0.0 seconds (filter OFF) to 100.0 seconds in 0.5 second increments. The default setting is 2.0 seconds.

CAUTION: If this parameter is set to an excessively high value, the control quality may be significantly impaired. The value chosen should be sufficiently large to attenuate stray noise on the process variable signal but no larger.

3.2.2 Process Variable Offset

This parameter is used to modify the actual process variable value (measured at the Controller's input terminals) in the following manner:

Offset PV value = Actual PV value + Process Variable Offset value.

The offset process variable value is used for all PV-dependent functions (control, display, alarm, recorder output etc.).

NOTE: This parameter value should be chosen with care. Any adjustment to this parameter is, in effect, a calibration adjustment. Injudicious application of values to this parameter could lead to the displayed process variable value bearing no meaningful relationship to the actual process variable value. There is no front panel indication when this parameter is in effect (i.e. has been set to a non-zero value).

The default value is 0.

3.2.3 Output Power 1

This parameter is the current Output 1 power level. It is a “Read Only” parameter and is not adjustable.

3.2.4 Output Power 2

This parameter is the current Output 2 power level (if Output 2 is fitted). It is a “Read Only” parameter and is not adjustable. If Output 2 is not fitted, this parameter display is not applicable.

3.2.5 Proportional Band 1

This parameter is the portion of the input span of the Controller over which the Output 1 power level is proportional to the displayed process variable value. It may be adjusted in the range 0.0% (i.e. ON/OFF control) to 999.9%. The default value of this parameter is 10.0%. The function of the Proportional Band 1 is illustrated in Figure 3-1.

3.2.6 Proportional Band 2

This parameter is the portion of the input span of the Controller over which the Output 2 power level is proportional to the displayed process variable value. It may be adjusted in the range 0.0% (i.e. ON/OFF control) to 999.9%. The default value of this parameter is 10.0%. This parameter is applicable only if Output 2 is fitted. In Figure 3-1, Proportional Band 2 is shown (a) with a non-zero value (Case 1 and Case 2) - PID control, and (b) with a zero value (Case 3) - ON/OFF control.

3.2.7 Reset (Integral Time Constant)

This parameter is adjustable in the range 1 second to 99 minutes 59 seconds and OFF (value greater than 99 minutes 59 seconds). This parameter is not applicable if Proportional Band 1 (see Subsection 3.2.5) is set to 0 (ON/OFF control).

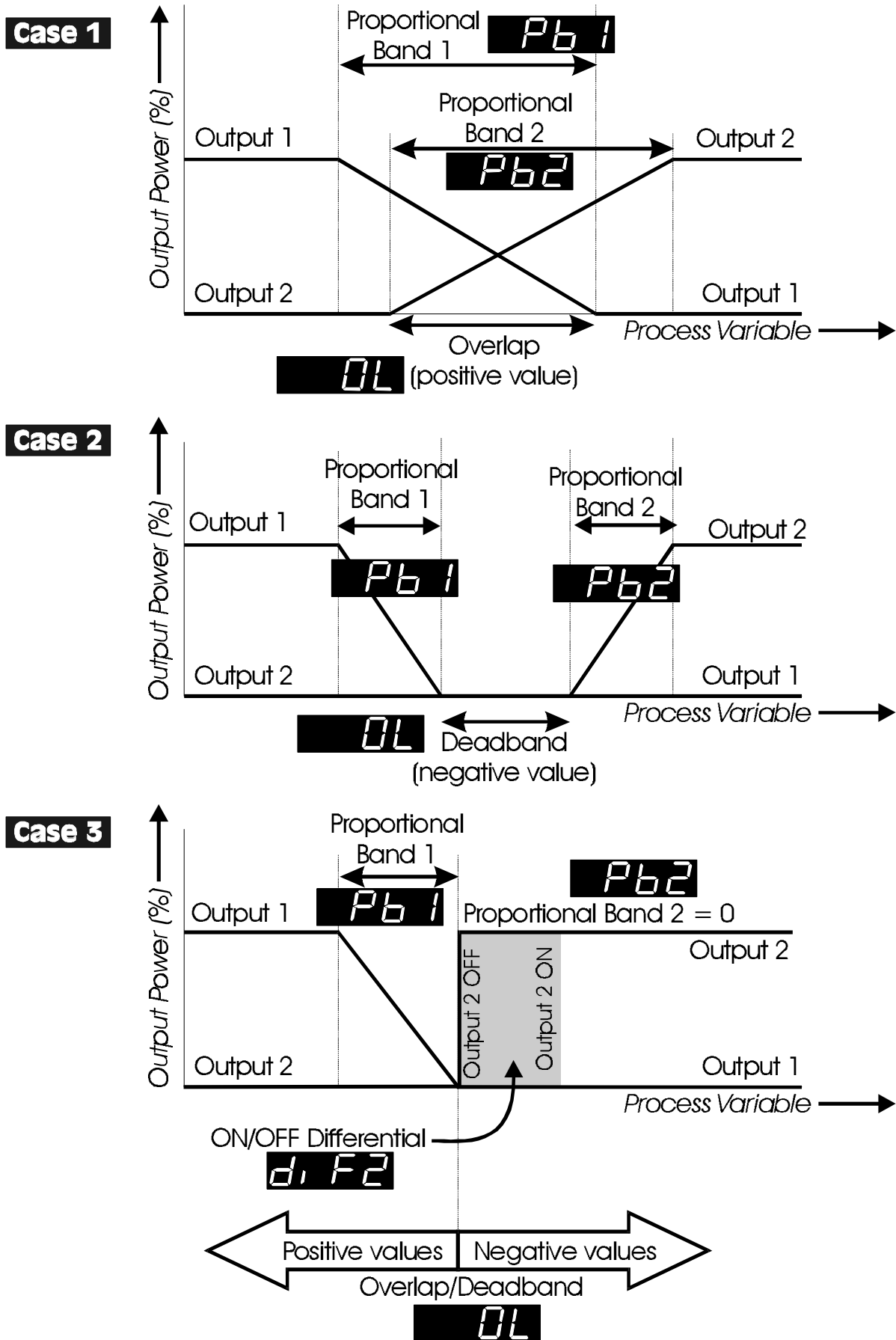

Figure 3-1 Proportional Band and Deadband/Overlap

3.2.8 Rate (Derivative Time Constant)

This parameter is adjustable in the range 00 seconds to 99 minutes 59 seconds. This parameter is not applicable if Proportional Band 1 (see Subsection 3.2.5) is set to 0 (ON/OFF control).

3.2.9 Overlap/Deadband

This defines the portion of the Proportional Band (Proportional Band 1 + Proportional Band 2) over which both outputs are active (or, in the case of a deadband, neither output is active). It is adjustable within the range -20% to $+20\%$ (negative value = deadband). The default value is 0% . The function of the overlap/deadband is illustrated in Figure 3-1. This parameter is not applicable if Proportional Band 1 = 0 or if Output 2 is not fitted.

Note that, with Output 2 set to ON/OFF control (Figure 3-1 Case 3), the Overlap/Deadband parameter has the effect of moving the ON Differential band of Output 2 to create an overlap (positive values) or a deadband (negative values). When Overlap/Deadband = 0, the "Output 2 OFF" edge of the Output 2 ON/OFF Differential band coincides with the point at which Output 1 reaches 0% .

3.2.10 Bias (Manual Reset)

This bias to the output power is expressed as a percentage of output power and is adjustable in the range 0% to 100% (if only Output 1 is fitted) or -100% to $+100\%$ (if both outputs are fitted). Its default value is 25% . This parameter is not applicable if Proportional Band 1 = 0.

3.2.11 ON/OFF Differential (Hysteresis)

This is a switching differential used when one or both outputs have been set to ON/OFF control (i.e. Proportional Band 1 or Proportional Band 2 or both = 0). This parameter may be adjusted within the range 0.1% to 10.0% of the input span of the Controller. The default value is 0.5% .

3.2.12 Setpoint High Limit

This is the maximum limit for setpoint adjustment. It should be set to a value which prevents the setpoint being given a value which will cause damage to the process being controlled. The Setpoint High Limit may be adjusted between the current setpoint value and Input Range Maximum. The default value is Input Range Maximum.

3.2.13 Setpoint Low Limit

This is the minimum limit for setpoint adjustment. It should be set to a value which prevents the setpoint being given a value which will cause damage to the

process being controlled. The Setpoint Low Limit may be adjusted between the Input Range Minimum and the current setpoint value. The default value is Input Range Minimum.

3.2.14 Recorder Output Scale Maximum

This parameter defines the value of process variable or setpoint (whichever is applicable) at which the Recorder Output reaches its maximum value; for example, for a 0 - 5V Recorder Output, this value corresponds to 5V. It may be adjusted within the range -1999 to 9999. The decimal point position for the Recorder Output is always the same as that for the process variable input range. The default value is Input Range Maximum. This parameter is not applicable if the Recorder Output option is not fitted.

NOTE: If this parameter is set to a value less than that for the Recorder Output Scale Minimum (see Subsection 3.2.15), the relationship between the process variable/setpoint value and the Recorder Output is reversed.

3.2.15 Recorder Output Scale Minimum

This parameter defines the value of the process variable or setpoint (whichever is applicable) at which the Recorder Output reaches its minimum value; for example, for a 0 - 5V Recorder Output, this value corresponds to 0V. It may be adjusted within the range -1999 to 9999. The decimal point position for the Recorder Output is always the same as that for the process variable input range. The default value is Input Range Minimum. This parameter is not applicable if the Recorder Output option is not fitted.

NOTE: If this parameter is set to a value greater than that for the Recorder Output Scale Maximum (see Subsection 3.2.14), the relationship between the process variable value and the Recorder Output is reversed.

3.2.16 Output 1 Power Limit

This parameter is used to limit the power level of Output 1 and may be used to protect the process being controlled. If no protection is required, this parameter may be set to 100% (the default value). It may be adjusted between 0% and 100%. This parameter is not applicable if Proportional Band 1 is set to 0.

If Soft Start is used, this power limit is applicable only during Soft Start. When Soft Start is completed, Output 1 power can go to 100%.

3.2.17 Output 1 Cycle Time

The cycle time value required is dependent upon the process being controlled and the type of output being used for Output 1. For a Relay Output, the cycle time should be as large as possible (whilst remaining compatible with the process

control requirements) in order to maximise relay life. For an SSR Drive Output, the cycle time may have a lower value (and thus satisfy the requirements of a fast-changing process variable e.g. flow or pressure). The permitted range of values is:

0.5, 1, 2, 4, 8, 16, 32, 64, 128, 256 or 512 seconds

The default value is 32 seconds. This parameter is not applicable if Proportional Band 1 is set to 0.

3.2.18 Output 2 Cycle Time

The cycle time value required is dependent upon the process being controlled and the type of output being used for Output 2. For a Relay Output, the cycle time should be as large as possible (whilst remaining compatible with the process control requirements) in order to maximise relay life. For an SSR Output, the cycle time may have a lower value (and thus satisfy the requirements of a fast-changing process variable e.g. flow or pressure). The permitted range of values is:

0.5, 1, 2, 4, 8, 16, 32, 64, 128, 256 or 512 seconds

The default value is 32 seconds. This parameter is not applicable if Proportional Band 1 or Proportional Band 2 is set to 0.

3.2.19 Process High Alarm 1 Value

This parameter, applicable only when Alarm 1 is selected to be a Process High alarm, defines the process variable value at or above which Alarm 1 will be active. Its value may be adjusted between Input Range Maximum and Input Range Minimum. Its default value is Input Range Maximum. The operation of a process high alarm is illustrated in Figure 3-2.

3.2.20 Process Low Alarm 1 Value

This parameter, applicable only when Alarm 1 is selected to be a Process Low alarm, defines the process variable value at or below which Alarm 1 will be active. Its value may be adjusted between Input Range Maximum and Input Range Minimum. Its default value is Input Range Minimum. The operation of a process low alarm is illustrated in Figure 3-2.

3.2.21 Band Alarm 1 Value

This parameter, applicable only if Alarm 1 is selected to be a Band Alarm, defines a band of process variable values, centred on the setpoint value. If the process variable value is outside this band, the alarm will be active. This parameter may be adjusted to be within $\pm(\text{input span})$ from the setpoint. The default value is five input units. The operation of a band alarm is illustrated in Figure 3-2.

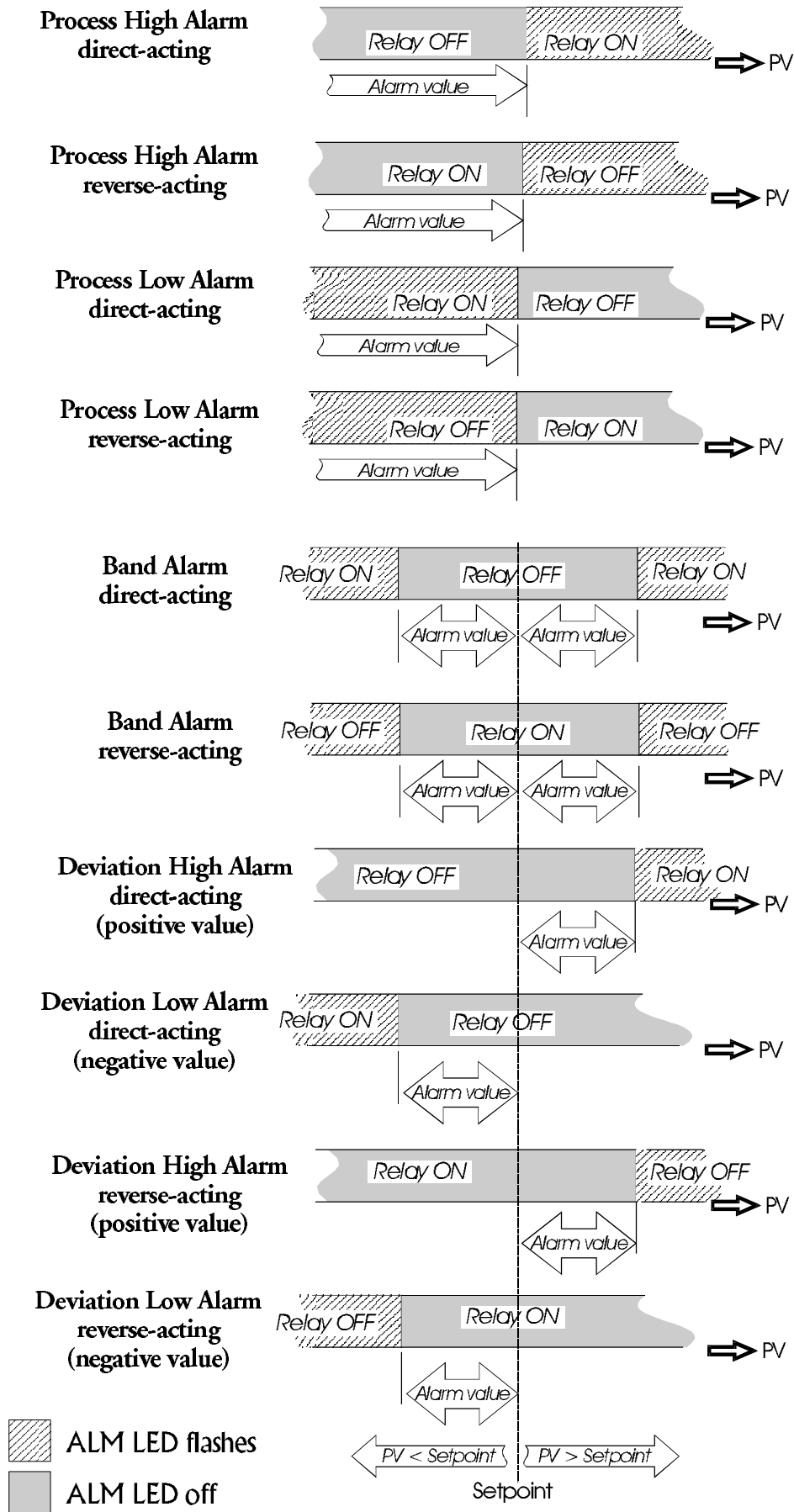

Figure 3-2 Alarm Operation

3.2.22 Deviation (High/Low) Alarm 1 Value

This parameter, applicable only if Alarm 1 is selected to be a Deviation High/Low Alarm, defines a value above (positive value - Deviation High alarm) or below (negative value - Deviation Low alarm) the setpoint; if the process variable deviates from the setpoint by a margin greater than that defined by this parameter, Alarm 1 goes active. This parameter value may be adjusted in the range \pm (input range) from setpoint. The default value is five input range units. The operation of Deviation Alarms is illustrated in Figure 3-2.

3.2.23 Alarm 1 Hysteresis

This parameter applies a hysteresis band on the “safe” side of the Alarm 1 value. Thus, Alarm 1 will become active when the Alarm 1 value is exceeded; Alarm 1 will become inactive when the process variable value is outside the hysteresis band on the “safe” side of the Alarm 1 value. Alarm 1 Hysteresis may be set to a value in the range 1 - 250 or 0.1 - 25.0 (as per input resolution). The effect of the hysteresis value on the operation of the different types of alarm is illustrated in Figure 3-3.

3.2.24 Process High Alarm 2 Value

This parameter, applicable only when Alarm 2 is selected to be a Process High alarm, defines the process variable value at or above which Alarm 2 will be active. Its value may be adjusted between Input Range Maximum and Input Range Minimum. Its default value is Input Range Maximum. The operation of a process high alarm is illustrated in Figure 3-2.

3.2.25 Process Low Alarm 2 Value

This parameter, applicable only when Alarm 2 is selected to be a Process Low alarm, defines the process variable value at or below which Alarm 2 will be active. Its value may be adjusted between Input Range Maximum and Input Range Minimum. Its default value is Input Range Minimum. The operation of a process low alarm is illustrated in Figure 3-2.

3.2.26 Band Alarm 2 Value

This parameter, applicable only if Alarm 2 is selected to be a Band Alarm, defines a band of process variable values, centred on the setpoint value. If the process variable value is outside this band, the alarm will be active. This parameter may be adjusted to be within \pm (input span) from the setpoint. The default value is five input units. The operation of a band alarm is illustrated in Figure 3-2.

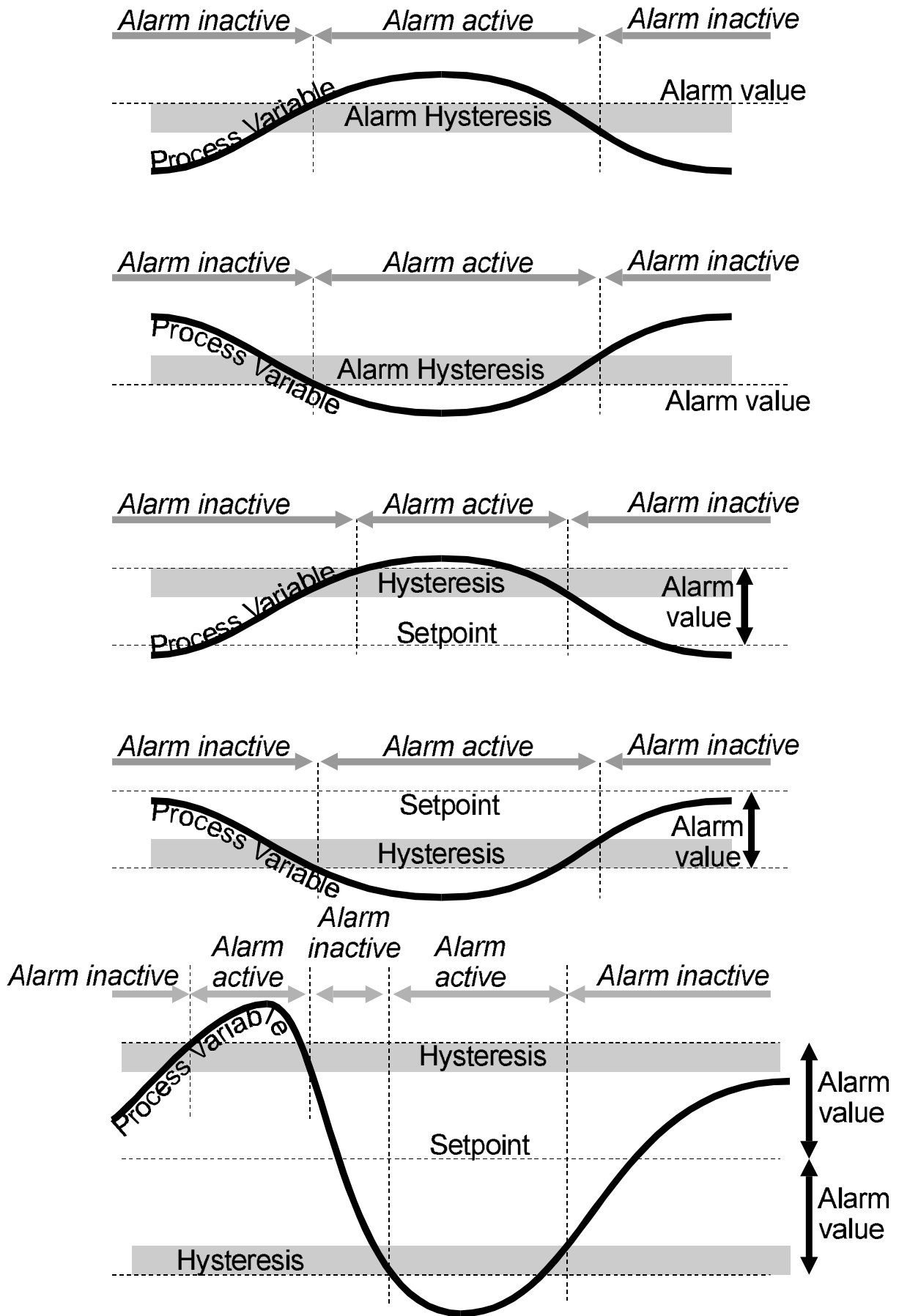

Figure 3-3 Alarm Hysteresis Operation

3.2.27 Deviation (High/Low) Alarm 2 Value

This parameter, applicable only if Alarm 2 is selected to be a Deviation High/Low Alarm, defines a value above (positive value - Deviation High alarm) or below (negative value - Deviation Low alarm) the setpoint; if the process variable deviates from the setpoint by a margin greater than that defined by this parameter, Alarm 2 goes active. This parameter value may be adjusted in the range \pm (input range) from setpoint. The default value is five input range units. The operation of Deviation Alarms is illustrated in Figure 3-2.

3.2.28 Alarm 2 Hysteresis

This parameter applies a hysteresis band on the “safe” side of the Alarm 2 value. Thus, Alarm 2 will become active when the Alarm 2 value is exceeded; Alarm 2 will become inactive when the process variable value is outside the hysteresis band on the “safe” side of the Alarm 2 value. Alarm 2 Hysteresis may be set to a value in the range 1 - 250 or 0.1 - 25.0 (as per input resolution). The effect of the hysteresis value on the operation of the different types of alarm is illustrated in Figure 3-3.

3.2.29 Heater Current High Scale Limit

This parameter defines the full scale value for the heater current range. It may be adjusted from 10.0A to 20.0A in 0.1A increments, and then from 21A to 100A in 1A increments. The default value is 50A. *Heater current range minimum is fixed at 0A.* This value also determines the Short Circuit Heater Break Alarm level (see below).

NOTE: If this parameter value is changed, the Heater Nominal Current, Low Heater Break Alarm Value and High Heater Break Alarm Value parameters are set to their default values (see Table 3-1).

3.2.30 Heater Nominal Current

This parameter defines a nominal value for the heater current and is only applicable if Heater Break Alarm Strategy is configured to Percentage Mode. It may be adjusted in the range 0A to Heater Current High Scale Limit. The default value is the Heater Current High Scale Limit. It can also be set automatically (in Operator Mode or Set Up Mode) to the heater current value at any instant by using “Quick Transfer” (see Subsection 2.13).

3.2.31 Low Heater Break Alarm Value

The Controller monitors two current values: ON-current (when Output 1 is on) and OFF-current (when Output 1 is off). This parameter defines a heater ON-current value below which the Low Heater Break Alarm will become active. It may be adjusted in the following ranges below the heater current nominal value:

If Heater Break Alarm Strategy = Percentage Mode: 0 - 100% of Heater Nominal Current (0 = OFF - value display blank, Low Heater Alarm forced inactive). Default value = 20% below heater nominal current. Hysteresis is half the Low Heater Break Alarm value.

If Heater Break Alarm Strategy = Absolute Mode: 0.1A/1A (dependent upon display resolution) - Heater Current High Scale Limit and 0 (OFF) - value display blank, Low Heater Alarm forced inactive. Default value = 0 (OFF). Hysteresis is 0.5A for 0.1A resolution and 2A for 1A resolution.

3.2.32 High Heater Break Alarm Value

The Controller monitors two current values: ON-current (when Output 1 is on) and OFF-current (when Output 1 is off). This parameter defines a heater ON-current value above which the High Heater Break Alarm will become active. It may be adjusted in the following ranges above the heater current nominal value:

If Heater Break Alarm Strategy = Percentage Mode: 0 - 100% of Heater Nominal Current (0 = OFF - value display blank, High Heater Alarm forced inactive). Default value is 0 (OFF). Hysteresis is half the High Heater Break Alarm value.

NOTE: Unless the High Heater Break Alarm is set OFF, if the heater current exceeds the Heater Current High Scale Limit, the High Heater Break Alarm will be forced active, even if the effective Alarm level is set higher than the Heater Current High Scale Limit.

If Heater Break Alarm Strategy = Absolute Mode: 0.1A/1A (dependent upon display resolution) - Heater Current High Scale Limit and 0 (OFF) - value display blank, High Heater Alarm forced inactive. Default value = 0 (OFF). Hysteresis is 0.5A for 0.1A resolution and 2A for 1A resolution.

3.2.33 Short Circuit Heater Break Alarm Enable/Disable

This parameter enables/disables the Short Circuit Heater break Alarm (1 = enabled, 0 = disabled). The default setting is 1 (enabled). The Controller monitors two current values: ON-current (when Output 1 is on) and OFF-current (when Output 1 is off). The Short Circuit Heater Break Alarm becomes active if the heater OFF-current exceeds 5% of Heater Current High Scale Limit. NOTE: This parameter is not available if Heater Break Input Type is configured to be SCRI.

3.2.34 Soft Start Setpoint

The use and operation of Soft Start are described in Subsection 2.4. The value of this parameter is adjustable (between Input Range Maximum and Input Range Minimum) in Set Up Mode only and is in force for the duration of the Soft Start.

When the Soft Start Time expires, the normal setpoint value is restored. Default value is Input Range Minimum.

3.2.35 Soft Start Time

This parameter defines the duration of the Soft Start from power-up. After this time expires, normal setpoint values will prevail. This parameter is adjustable in the range 15 seconds to 59 minutes 45 seconds (in 15-second increments) and OFF (less than 15 seconds); the default value is OFF.

3.2.36 Auto Pre-Tune Enable/Disable

This parameter determines whether or not Pre-Tune is activated automatically on power-up or not (0 = Disabled, 1 = Enabled). The default setting is 0 (Disabled).

3.2.37 AM Key Usage

This parameter may be set to one of three options:

Output Turn-off: Pressing the **AM** key causes the Controller to change from automatic control to control output(s) being switched off, or vice versa.

Auto/Manual Control Selection: Pressing the **AM** key causes the Controller to change from automatic control to manual control (operator can then adjust output power from the front panel) or vice versa.

Heater Current Display/Manual Control Disable: Pressing the **AM** key causes the Controller displays to change from the current display to the Process Variable/Heater Current display and thereafter switches between the PV/Heater Current display and the PV/SP display. Manual control is disabled.

The default setting is Output Turn-Off.

3.2.38 Setpoint Ramp Enable/Disable

This parameter enables/disables use of the setpoint ramping feature at user level (0 = Disabled, 1 = Enabled). The default setting is 0 (Disabled).

3.2.39 Communications Write Enable/Disable

This parameter enables/disables Write operations (i.e. the *changing* of parameter values/settings) via the RS485 communications link, if the Communications Option PCB is fitted (0 = Disabled, 1 = Enabled). The default setting is 1 (Enabled). Parameters can be *interrogated* via the link, regardless of the setting of this parameter.

3.2.40 Setpoint Strategy

This parameter determines whether the active setpoint value shown in the Operator Mode process variable/setpoint display is adjustable or not (1 = not adjustable, 2 = adjustable). The default setting is 1. NOTE: During a Soft Start, the active setpoint value cannot be altered, regardless of the setting of this parameter.

3.2.41 Lock Value

This parameter defines the four-digit code required to enter Set Up Mode. It may be adjusted in the range 0 to 9999. The default setting is 10.

3.3 OPERATOR MODE DISPLAYS

Once the complete cycle of Set Up Mode parameters has been displayed, the user may then step through the Operator Mode displays (see Section 2), making adjustments where required, before re-starting the Set Up Mode parameter cycle, as shown in Table 3-1.

3.4 TUNING THE CONTROLLER MANUALLY

3.4.1 Controllers Fitted with Output 1 Only

Before starting to tune the Controller to the load, check that the Setpoint High and Low Limits (**SPhi** and **SPLo**) are set to safe levels - see Subsections 3.2.12 and 3.2.13.

The following simple technique may be used to determine values for proportional band (**Pb1**), derivative time constant (**rAtE**) and integral time constant (**rSEt**).

NOTE: This technique is suitable for use only with processes which are not harmed by large fluctuations in the process variable. It provides an acceptable basis from which to start fine tuning for a wide range of processes.

1. Set the setpoint to the normal operating process value (or to a lower value if overshoot beyond this value is likely to cause damage).
2. Select ON/OFF Control (i.e. set **Pb1** = 0).
3. Switch on the process. Under these conditions, the process variable will oscillate about the setpoint and the following parameter values should be noted:
 - (a) The peak-to-peak variation (**P**) of the first cycle i.e. the difference between the highest value of the first overshoot and the lowest value of the first undershoot - see Figure 3-4)
 - (b) The cycle time (**T**) of this oscillation in minutes (see Figure 3-4)
4. The control parameters should then be set at follows:

$$\mathbf{Pb1} = \frac{P}{ScaleRange} \times 100$$

$$\mathbf{rSEt} = T \text{ minutes}$$

$$\mathbf{rAtE} = \frac{T}{6} \text{ minutes}$$

NOTE: After setting up the parameters, set the Controller to Operator Mode (see Subsection 3.6) to prevent unauthorised adjustment to the values.

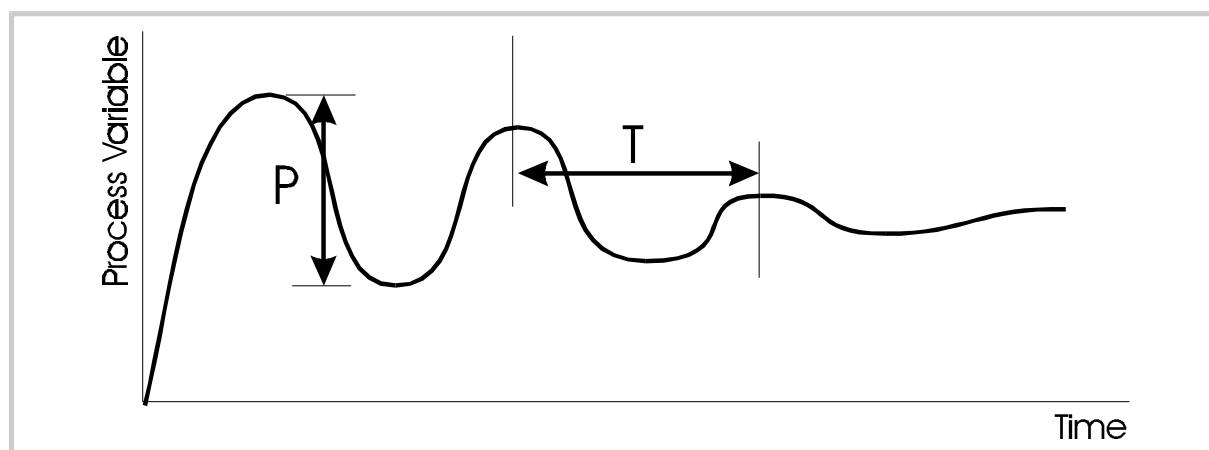

Figure 3-4 Manual Tuning Parameters (Output 1 only)

3.4.2 Controllers Fitted with Output 1 and Output 2

Before starting to tune the Controller to the load, check that the Setpoint High and Low Limits (**SPhi** and **SPLo**) are set to safe levels - see Subsections 3.2.12 and 3.2.13.

The following simple technique may be used to determine values for proportional band (**Pb1**), derivative time constant (**rAtE**) and integral time constant (**rSEt**).

NOTE: This technique is suitable for use only with processes which are not harmed by large fluctuations in the process variable. It provides an acceptable basis from which to start fine tuning for a wide range of processes.

1. Tune the Controller using Output 1 only as described in Subsection 3.4.1.
2. Set **Pb2** to the same value as **Pb1** and monitor the operation of the Controller in dual output mode. If there is a tendency to oscillate as control passes into the Output 2 proportional band, increase the value of **Pb2**. If the process appears to be over-damped in the region of the Output 2 proportional band, decrease the value of **Pb2**.
3. When values of proportional bands, integral time constant and derivative time constant have been determined for tuning, if there is a "kick" as control passes from one output to the other, set **OL** to a positive value to introduce some overlap. Adjust the value of **OL** by trial and error until satisfied.

3.5 SELF-TUNE

Once the Controller has been manually tuned, Self-Tune may be used in Operator Mode to enhance further the response of the Controller (see Subsection 2.15).

3.6 EXIT FROM SET UP MODE

To leave Set Up Mode, select the initial Operator Mode display (process variable/setpoint) then depress the Raise and Function keys simultaneously, whereupon the Controller will return to Operator Mode.

NOTE: An automatic return to Operator mode will be executed if there is no key activity in Set Up Mode for two minutes.

4 MODBUS RTU COMMUNICATIONS

The Plastics Controller may be equipped with two-wire RS485-compatible serial communications, by which means communication may occur between the Controller and a master device (e.g. a computer or terminal).

4.1 COMMUNICATIONS WRITE ENABLE/DISABLE

When Communications Write operations are enabled (in Set Up Mode - see Subsection 3.2.39), the Controller parameters may be adjusted by the master device via the serial communications link. If communications Writes are disabled, the Controller will not adjust or change any parameters in response to commands received from the master device and will send a negative acknowledgement in response to such commands. Whether communications Writes are enabled or disabled, the Controller will return the requested information in response to interrogation from the master device.

4.2 PHYSICAL REQUIREMENTS

4.2.1 Character Transmission

The data format is fixed to be one start bit, eight data bits and one stop bit. The Baud rate may be selected to be 1200, 2400, 4800 (default) or 9600 Baud. The parity is selectable to be even, odd, or none.

4.2.2 Line Turn-round

The line turn-round timings adhere to the industry standard.

4.3 MODBUS RTU PROTOCOL

The standard RS485 Communications Option and the Enhanced RS485 Communications option both use the industry standard MODBUS protocol. The following restrictions are imposed:

Baud rates may be set to 1200, 2400, 4800 or 9600 Baud only.

Support for multi-parameter Write operations is limited to support of the Multi-Word Write Function (Number 16) but permits writing of one parameter only per message.

The multi-parameter Read operations support a maximum of 10 parameters per message.

The following MODBUS functions are supported (JBUS names, where applicable, are given in italics):

Function	MODBUS Function Number
Read Coil Status (<i>Read n Bits</i>)	01/02
Read Holding Registers (<i>Read n Words</i>)	03/04
Force Single Coil (<i>Write 1 Bit</i>)	05
Preset Single Register (<i>Write 1 Word</i>)	06
Loopback Diagnostic Test	08
Preset Multiple Registers (<i>Write n Words</i>)	16

The Controller will identify itself in response to a Read Holding Registers message which enquires the values of word parameters 121 and 122 (see Table 4-2); MODBUS Function 17 (Report Slave ID) is not supported.

4.3.1 Message Formats

The first character of every message is the Controller address, in the range 1 - 128 (standard RS485) or 1 - 255 (enhanced RS485) and 0 for broadcast messages. The second character is always the Function Number. The contents of the remainder of the message depends upon this Function Number.

In most cases the Controller is required to reply to the message by echoing the address and Function Number, together with an echo of all or part of the message received (in the case of a request to write a value or carry out a command) or the information requested (in the case of a Read Parameter operation). Broadcast messages are supported at address 0 (to which the Controller responds by taking some action *without sending back any reply*).

Data is transmitted as eight-bit binary bytes with one start bit, one stop bit and optional parity checking (none, even or odd). A message is terminated simply by a delay of more than three character lengths at the Baud rate used; any character received after such a delay is considered to be the potential address at the start of a new message.

Since only the RTU form of the protocol is supported, each message is followed by a two-byte CRC 16 (a 16-bit cyclic redundancy checksum). This checksum is calculated in accordance with a formula which involves recursive division of the data by a polynomial, with the input to each division being the remainder of the results of the previous division. The dividing polynomial is

$$2^{16} + 2^{15} + 2^2 + 1 \text{ (Hex 18005)}$$

but this is modified in two ways:

- (a) because the bit order is reversed, the binary pattern is also reversed, making the most significant bit (MSB) the right-most bit, and

(b) because only the remainder is of interest, the right-most (most significant) bit can be discarded.

Thus, the polynomial has the value Hex A001. The CRC algorithm is shown in Figure 4-1.

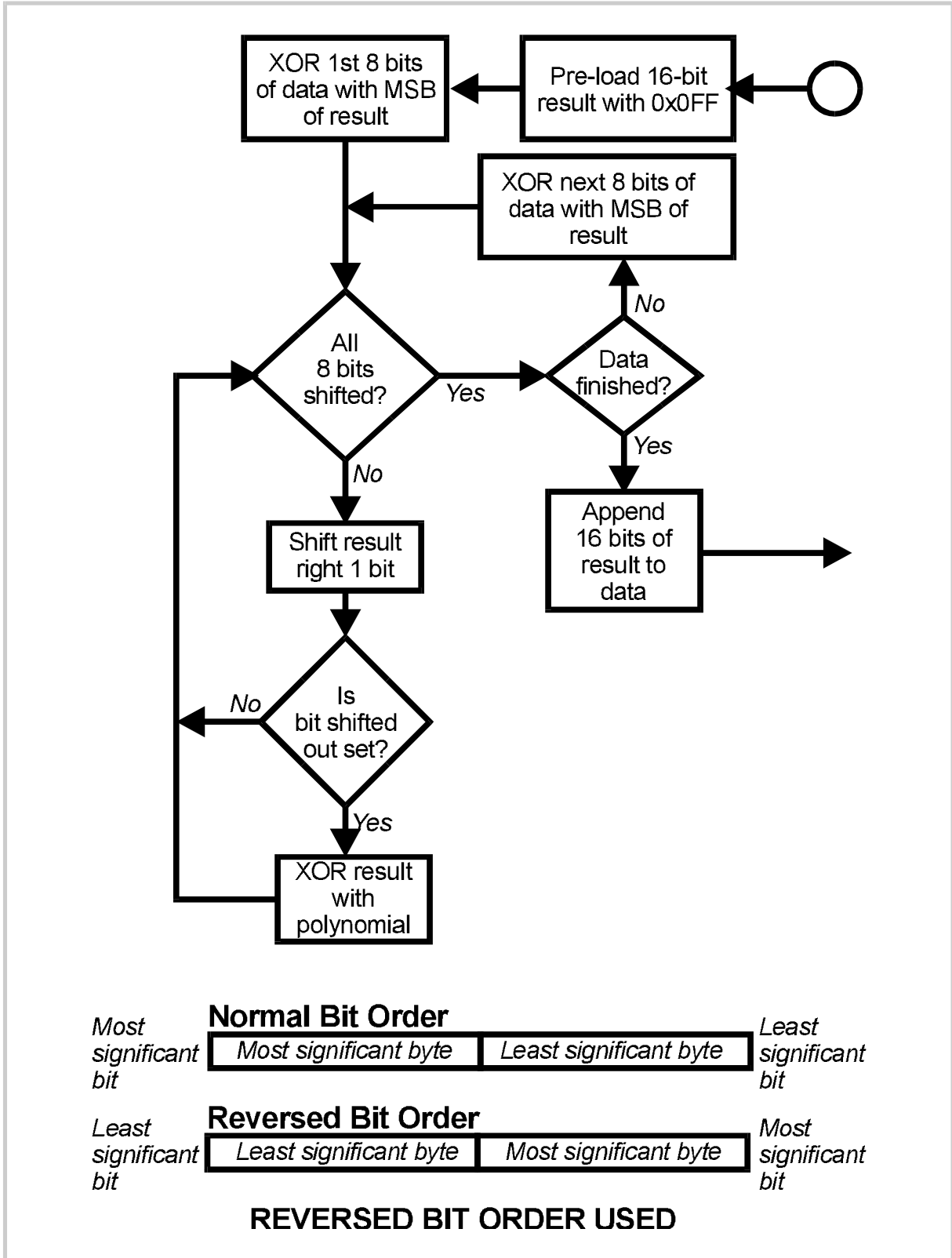

Figure 4-1 Cyclic Redundancy Check Algorithm

Read Coil Status (*Read n Bits*) - 01/02

The message sent to the Controller consists of eight bytes:

The normal reply will echo the first two characters of the message received followed by a single-byte data byte count (which will not include itself or the CRC). For this message, there will be one byte of data per eight bits-worth of information requested, with the least significant bit of the first data byte transmitted depicting the state of the lowest-numbered bit required.

This function is used mostly to report controller status information; thus, a bit set to 1 indicates that the corresponding feature is currently active/enabled and a bit set to 0 indicates that the corresponding feature is currently inactive/disabled.

If an exact multiple of eight bits is not requested, the data padding with trailing zeros is used to preserve the eight-bit format. After the data has been transmitted, the CRC16 value is sent.

Read Holding Registers (*Read n Words*) - 03/04

The message sent to the Controller to obtain the value of one or more registers comprises the following eight bytes:

The normal reply will echo the first two characters of the message received followed by a single-byte data byte count (which will not include itself or the CRC). For this message, the count value equals the number of parameter values read multiplied by two. Following the byte count, the specified number of parameter values are transmitted, followed by the CRC16 bytes:

Force Single Coil (*Write 1 Bit*) - 05

The message received by the Controller is eight bytes long, comprising the standard pre-amble and the address of the bit to be forced, followed by a two-byte word whose most significant byte contains the desired truth value of the bit expressed as 0xFF (TRUE) or 0x00 (FALSE):

Normally, this function is used to control such features as Auto-Manual Control selection and tuning (Pre-Tune, Self-Tune). The normal reply sent by the Controller will be a byte-for-byte echo of the message received.

Preset Single Register (*Write 1 Word*) - 06

The message sent to the Controller comprises eight bytes: the address and Function Number (as usual), the address of the parameter to be written, the two-byte value to which the parameter is to be set and the CRC16 bytes:

The normal response from the Controller is a complete echo of the received message.

Loopback Diagnostic Test - 08

This is an eight-byte message comprising the usual pre-amble, a two-byte diagnostic code, two bytes of data and the CRC16 bytes:

The only diagnostic code supported is 00. The normal response is an exact echo of the received message.

Preset Multiple Registers (*Write n Words*) - 16

This is an eleven-byte message. only one parameter may be written for each received message. The usual pre-amble is followed by the address of the parameter to be written, a two-byte word count (always set to 1), a single-byte byte count (always set to 2), the value to be written and the CRC16 bytes:

The Controller normally responds with the following eight-bit reply:

4.3.2 Error and Exception Responses

If a received message contains a corrupted character (parity check failure, framing error etc.) or if the CRC16 check fails, or if the received message is otherwise syntactically flawed (e.g. byte count or word count is incorrect), the Controller will ignore that message.

If the received message is syntactically correct but nonetheless contains an illegal value, the Controller will send a five-byte exception response as follows:

The Function Number byte contains the function number contained in the message which caused the error, with its top bit set (i.e. Function 3 becomes 0x83) and the Exception Number is one of the following codes:

For error and exception responses specific to a parameter, see notes in Table 4-1 and Table 4-2.

NOTE: Writing a parameter value equal to its current value is a valid transaction; this will not cause an error response.

4.3.3 Address Range

With standard RS485 communications configured, the selectable address range is 1 - 128. With enhanced RS485 communications configured, the selectable address range is 1 - 255. The Controller will respond appropriately to Address 0 - broadcast messages - no matter what address is selected.

NOTE: The total receiver load on the RS485 link *must not exceed 32 standard RS485 unit loads*. This applies to both standard and enhanced RS485 communications. A Plastics Controller presents $\frac{1}{4}$ standard RS485 load, so a maximum of 128 Controllers are permitted. With other devices

connected, the limit is dictated by the sum total of all the RS485 receiver loadings.

4.3.4 Bit Parameters

The bit parameters are shown in Table 4-1.

4.3.5 Word Parameters

The word parameters are shown in Table 4-2.

Table 4-1 MODBUS Bit Parameters

Parameter	No.	Notes
Comms. Write Status	1	Read Only. 1 = enabled, 0 = disabled
Auto/Manual Control	2	1 = Manual, 0 = Auto
Self-Tune ⁴	3	1 = activate(d), 0 = dis-engage(d)
Pre-Tune ⁵	4	1 = activate(d), 0 = dis-engage(d)
Alarm 1 Status	5	Read Only. 1 = active, 0 = inactive
Alarm 2 Status	6	Read Only. 1 = active, 0 = inactive
Setpoint Ramp Enable/Disable	7	1 = enable(d), 0 = disable(d)
Parameter Changed ²	8	Read Only. 1 = change, 0 = no change
Auto/Output Turn-Off ³	9	1 = Output Turn-Off, 0 = Auto Control
High Heater Break Alarm Status	10	Read Only. 1 = active, 0 = inactive
Low Heater Break Alarm Status	11	Read Only. 1 = active, 0 = inactive
Short-Circuit Heater Break Alarm Status	12	Read Only. 1 = active, 0 = inactive
Heater Break Current Transfer (Quick Transfer)	13	1 = initiate transfer, 0 = no transfer. This bit will always be 0 when read.
Short-Circuit Heater Break Alarm Enable/Disable	14	1 = enable(d), 0 = disable(d)
Reserved	15	
Reserved	16	

NOTES

1. Not available if **AM** Key Usage (see Subsection 3.2.37) is not set to Auto/Manual Control Selection.

2. This indicates whether a parameter has been changed from the front panel since the last interrogation via the communications link. Every interrogation of this bit resets it to 0.

3. Not available if **AM** Key Usage (see Subsection 3.2.37) is not set to Auto/Output Turn-Off Selection.

4. If Setpoint Ramping is enabled, an Activate Self-Tune command will not take effect until the setpoint has reached its target value.

5. An Activate Pre-Tune command will fail if the process variable is within 5% of input span from the setpoint.

6. Not available if Heater Break Input Type is configured to be SCRI.

7. Available only if Heater Break Alarm Strategy is set to Percentage Mode.

Table 4-2 MODBUS Word Parameters

Parameter	No.	Notes
Process Variable	1	Read Only
Setpoint	2	Target setpoint if ramping
Output Power	3	Read Only if not in Manual Control mode
Arithmetic Deviation	4	Read Only
Proportional Band 2	5	
Proportional Band 1	6	
Status	7	Read Only (see Table 4-1)
Reset (Integral Time Constant)	8	
Rate (Derivative Time Constant)	9	
Output 1 Cycle Time	10	
Scale Range Low	11	Read Only
Scale Range High	12	Read Only
Alarm 1 value	13	
Alarm 2 value	14	
Manual Reset (Bias)	15	
Overlap/Deadband	16	
ON/OFF Differential	17	
Decimal Point Position	18	Read Only
Output 2 Cycle Time	19	
Output 1 Power Limit	20	
Control Setpoint value	21	Read Only - ramping setpoint if ramping
Setpoint High Limit	22	
Setpoint Low Limit	23	
Setpoint Ramp Rate	24	
Input Filter Time Constant	25	
Process Variable Offset	26	
Recorder Output Maximum	27	
Recorder Output Minimum	28	
Heater Current High Scale Limit	29	
Heater Nominal Current	30	Accessible only if Heater Break Alarm Strategy is set to Percentage Mode

Table 4-3 MODBUS Word Parameters (Cont.)

Parameter	No.	Notes
Low Heater Break Alarm value	31	0 - 100% and OFF or 0.1A/1A - Heater Current High Scale Limit (see Subsection 4.4.6.5)
High Heater Break Alarm value	32	0 - 100% and OFF or 0.1A/1A - Heater Current High Scale Limit (see Subsection 4.4.6.6)
Heater Current	33	Read Only
AM Key Usage	34	Read Only
Alarm 1 Hysteresis	35	1 - 250 or 0.1 - 25.0 (as per Heater Current High Scale Limit)
Alarm 2 Hysteresis	36	1 - 250 or 0.1 - 25.0 (as per Heater Current High Scale Limit)
Soft Start Setpoint	37	
Soft Start Time	38	
Soft Start Time Remaining	39	Read Only - Returns 0 if not in Soft Start
Manufacturer ID	121	Read Only - 231 (representing "W1")
Equipment ID	122	Read Only - number 6600

NOTES

1. The values of Word Parameters 29 and 30 are always to 0.1A resolution.
2. If Heater Break Alarms are set to Absolute Current Mode, values of Word Parameters 31 and 32 will be to 0.1A resolution.
3. If Heater Current High Scale Limit (Word Parameter 29) is set to >20A, the Controller operates to 1A resolution, in which case all the above Word Parameters' least significant decimal digit will return) and, in Write operations, that digit will be truncated.

4.4 INDIVIDUAL PARAMETERS

4.4.1 Input Parameters

4.4.1.1 PROCESS VARIABLE - Word Parameter 1

This Read Only word parameter indicates the current value of the process variable.

4.4.1.2 PROCESS VARIABLE OFFSET - *Word Parameter 26*

This word parameter may be modified/interrogated. It modifies the actual process variable value (as measured at the Controller's input terminals) in the following manner:

$$\text{Modified PV value} = \text{Actual PV value} + \text{process variable offset value}$$

The modified PV value is limited by Range Maximum and Range Minimum and is used for display and alarm purposes and for recorder outputs.

NOTE: This parameter value should be selected with care. Any adjustment to this parameter is, in effect, an adjustment to the Controller's calibration. Injudicious application of values to this parameter could lead to the displayed PV value having no meaningful relationship to the actual PV value.

4.4.1.3 SCALE RANGE MAXIMUM - *Word Parameter 12*

This Read Only word parameter indicates the maximum process input value.

4.4.1.4 SCALE RANGE MINIMUM - *Word Parameter 11*

This Read Only word parameter indicates the minimum process input value.

4.4.1.5 DECIMAL POINT POSITION - *Word Parameter 18*

This Read Only word parameter indicates the input range decimal point position.

4.4.1.6 INPUT FILTER TIME CONSTANT - *Word Parameter 25*

This word parameter may be modified/interrogated. The Controller input is equipped with a digital filter which is used to filter out any extraneous impulses on the process variable. This filtered PV is used for all PV-dependent functions (control, alarms etc.). The time constant for this filter may be adjusted in the range 0.0 seconds (filter OFF) to 100.0 seconds in 0.5 second increments. The default setting is 2.0 seconds.

CAUTION: If this parameter is set to an excessively high value, the control quality may be significantly impaired. The value chosen should be sufficiently large to attenuate stray noise on the process variable signal but no larger.

4.4.2 Output Parameters

4.4.2.1 OUTPUT POWER VALUE - *Word Parameter 3*

The value of this word parameter may range between 0% and 100% (for a single-output Controller) or -100% and 100% (for a dual-output Controller). If

Manual control is not selected, this word parameter is Read Only; if Manual control is selected, this parameter may be adjusted.

4.4.2.2 OUTPUT 1 POWER LIMIT - *Word Parameter 20*

This word parameter may be modified/interrogated. It defines the power limit for Output 1 and may be set in the range 0% to 100% of full power. The default value is 100%. The decimal point position is fixed at 1 decimal place. If Soft Start is used, this power limit is applicable only during Soft Start. When Soft Start is completed, Output 1 power can go to 100%.

4.4.2.3 OUTPUT 1 CYCLE TIME - *Word Parameter 10*

This parameter may be modified/interrogated. The value to which this is set is dependent upon the output type and the nature of the process to be controlled. For relay outputs, this parameter should be set to as large a value as possible (consistent with satisfactory control of the process) in order that the life of the relay be maximised. For SSR Drive and Solid State outputs, lower values may be used. The decimal point position is set at 1 decimal place.

NOTE: Cycle Time values must be written correctly i.e. the value must be a power of 2 in the range 0.5 - 512 (0.5, 1, 2, 4, 8, etc.).

4.4.2.4 OUTPUT 2 CYCLE TIME - *Word Parameter 19*

This parameter may be modified/interrogated. The value to which this is set is dependent upon the output type and the nature of the process to be controlled. For relay outputs, this parameter should be set to as large a value as possible (consistent with satisfactory control of the process) in order that the life of the relay be maximised. For SSR Drive and Solid State outputs, lower values may be used. The decimal point position is set at 1 decimal place.

NOTE: Cycle Time values must be written correctly i.e. the value must be a power of 2 in the range 0.5 - 512 (0.5, 1, 2, 4, 8, etc.).

4.4.2.5 RECORDER OUTPUT MAXIMUM VALUE - *Word Parameter 27*

This word parameter may be modified/interrogated. It defines the maximum value for the Controller's Recorder Output and may be adjusted within the range -1999 to 9999. This value corresponds to the Input Scale Maximum and the decimal point position will always be the same as that for the input.

NOTE: If this parameter is set to a value less than the Recorder Output Minimum Value, the sense of the Recorder Output is reversed.

4.4.2.6 RECORDER OUTPUT MINIMUM VALUE - *Word Parameter 28*

This word parameter may be modified/interrogated. It defines the minimum scale value for the Controller's Recorder Output and may be adjusted within the range -1999 to 9999. This value corresponds to the Input Scale Minimum and the decimal point position will always be the same as that for the input. If this parameter is set to a value greater than the Recorder Output Maximum Value, the sense of the Recorder Output is reversed.

4.4.3 Heater Current Parameters

4.4.3.1 HEATER CURRENT HIGH SCALE LIMIT - *Word Parameter 29*

This word parameter defines the full scale value for the heater current range. It may be adjusted from 10.0A to 20.0A in 0.1A increments, and then from 21A to 100A in 1A increments. The default value is 50A. *Heater current range minimum is fixed at 0A.*

NOTE: If this parameter value is changed, the Heater Nominal Current, Low Heater Break Alarm Value and High Heater Break Alarm Value parameters are set to their default values.

4.4.3.2 HEATER NOMINAL CURRENT - *Word Parameter 30*

This word parameter defines a nominal value for the heater current. It may be adjusted in the range 0A to Heater Current High Scale Limit value. The default value is the Heater Current High Scale Limit value. *This parameter is accessible only if Heater Break Alarm Strategy is configured to Percentage Mode.*

4.4.3.3 HEATER CURRENT - *Word Parameter 33*

This Read Only word parameter indicates the most recent valid heater current value at the instant the message is received; it is equivalent to calling up the heater current display from the front panel.

4.4.4 Setpoint Parameters

4.4.4.1 SETPOINT VALUE - *Word Parameter 2*

This word parameter may be modified/interrogated. It can be set to any value between Setpoint High Limit (see Subsection 4.4.4.3) and Setpoint Low Limit (see Subsection 4.4.4.4). When the setpoint is ramping, this is the target setpoint value.

4.4.4.2 SETPOINT RAMP RATE - *Word Parameter 24*

This word parameter may be modified/interrogated. It defines the rate at which the current setpoint can be made to ramp and can be set to a value in the range

1 - 9999 increments per hour or 0 (ramping OFF). The decimal point position is as for the input range.

4.4.4.3 SETPOINT HIGH LIMIT - *Word Parameter 22*

This word parameter may be modified/interrogated. It defines the maximum value which may be assigned to the setpoint. The default value is Input Range Maximum. The permissible range is between the current setpoint value and Input Range Maximum. The decimal point position is as for the input range.

4.4.4.4 SETPOINT LOW LIMIT - *Word Parameter 23*

This word parameter may be modified/interrogated. It defines the minimum value which may be assigned to the setpoint. The default value is Input Range Minimum. It may be set to a value between Input Range Minimum and the current value of the setpoint. The decimal point position is as for the input range.

4.4.4.5 CONTROL SETPOINT - *Word Parameter 21*

This Read Only word parameter is the setpoint value being used by the Controller *at the instant the message is received*. When the setpoint is ramping, this is the ramping setpoint value.

4.4.5 Soft Start Parameters

4.4.5.1 SOFT START SETPOINT - *Word Parameter 37*

This word parameter may be modified/interrogated. It defines the value of setpoint to be used during a soft start. It may be adjusted between Input Range Minimum and Input Range Maximum. The default value is Input Range Minimum.

4.4.5.2 SOFT START TIME - *Word Parameter 38*

This word parameter may be modified/interrogated. It defines the duration of the Soft Start. It may be adjusted in 15-second increments within the range 0 (OFF) to 59 minutes 45 seconds. A value which is not an exact multiple of 15 seconds is treated as an invalid value. The default value is 0 (OFF).

4.4.5.3 SOFT START TIME REMAINING - *Word Parameter 39*

This Read Only word parameter is the time remaining for a Soft Start *at the instant the message is received*. When there is no Soft Start currently in effect, a value of 0 is returned.

4.4.6 Alarm Parameters

4.4.6.1 ALARM 1 VALUE - Word Parameter 13

This word parameter may be modified/interrogated. It defines the level at which Alarm 1 will go active. The decimal point position is as for the input range.

4.4.6.2 ALARM 1 HYSTERESIS - Word Parameter 35

This word parameter applies a hysteresis band on the "safe" side of the Alarm 1 value. Thus, Alarm 1 will become active when the Alarm 1 value is exceeded; Alarm 1 will become inactive when the process variable value is outside the hysteresis band on the "safe" side of the Alarm 1 value. Alarm 1 Hysteresis may be set to a value in the range 1 - 250 or 0.1 - 25.0 (as per Heater Current High Scale Limit). The effect of the hysteresis value on the operation of the different types of alarm is illustrated in Figure 3-3.

4.4.6.3 ALARM 2 VALUE - Word Parameter 14

This word parameter may be modified/interrogated. It defines the level at which Alarm 2 will go active. The decimal point position is as for the input range.

4.4.6.4 ALARM 2 HYSTERESIS - Word Parameter 36

This word parameter applies a hysteresis band on the "safe" side of the Alarm 2 value. Thus, Alarm 2 will become active when the Alarm 2 value is exceeded; Alarm 2 will become inactive when the process variable value is outside the hysteresis band on the "safe" side of the Alarm 2 value. Alarm 2 Hysteresis may be set to a value in the range 1 - 250 or 0.1 - 25.0 (as per Heater Current High Scale Limit). The effect of the hysteresis value on the operation of the different types of alarm is illustrated in Figure 3-3.

4.4.6.5 LOW HEATER BREAK ALARM VALUE - Word Parameter 31

This word parameter defines a heater current value below which the Low Heater Break Alarm will become active. It may be adjusted in the following ranges below the Heater Nominal Current:

If Heater Break Alarm Strategy = Percentage Mode: 0 - 100% of Heater Nominal Current (0 = OFF - value display blank, Low Heater Alarm forced inactive). Default value = 20% below heater nominal current. Hysteresis is half the Low Heater Break Alarm value.

If Heater Break Alarm Strategy = Absolute Mode: 0.1A/1A (dependent upon display resolution) - Heater Current High Scale Limit and 0 (OFF) - value display blank, Low Heater Alarm forced inactive. Default value = 0 (OFF). Hysteresis is 0.5A for 0.1A resolution and 2A for 1A resolution.

4.4.6.6 HIGH HEATER BREAK ALARM VALUE - *Word Parameter 32*

This word parameter defines a heater current value above which the High Heater Break Alarm will become active. It may be adjusted in the following ranges above the Heater Nominal Current:

If Heater Break Alarm Strategy = Percentage Mode: 0 - 100% of Heater Nominal Current (0 = OFF - value display blank, High Heater Break Alarm forced inactive). Default value = 0 (OFF). Hysteresis is half the High Heater Break Alarm value.

NOTE: Unless the High Heater Break Alarm is set OFF, if the heater current exceeds the Heater Current High Scale Limit, the High Heater Break Alarm will be forced active, even if the High Heater Break Alarm level is set higher than the Heater Current High Scale Limit.

If Heater Break Alarm Strategy = Absolute Mode: 0.1A/1A (dependent upon display resolution) - Heater Current High Scale Limit and 0 (OFF) - value display blank, High Heater Break Alarm forced inactive. Default value = 0 (OFF). Hysteresis is 0.5A for 0.1A resolution and 2A for 1A resolution.

4.4.7 Tuning Parameters

4.4.7.1 RATE (DERIVATIVE TIME CONSTANT) - *Word Parameter 9*

This word parameter may be modified/interrogated. It defines the derivative time constant for the control algorithm. The decimal point is used as the separator between the minutes and seconds digits (i.e. set to 2 decimal places); the decimal point position must be as described, otherwise modification will not occur.

4.4.7.2 RESET (INTEGRAL TIME CONSTANT) - *Word Parameter 8*

This word parameter may be modified/interrogated. The {DATA} element is in a format in which the first two digits represent minutes and the second two digits represent seconds. The decimal point position complies with this format and the decimal point is used as a separator between the minutes digits and the seconds digits. The decimal point must be in the correct position for modification to occur.

4.4.7.3 MANUAL RESET (BIAS) - *Word Parameter 15*

This word parameter may be modified/interrogated. The decimal point position is as for the input range.

4.4.7.4 **ON/OFF DIFFERENTIAL** - *Word Parameter 17*

This word parameter may be modified/interrogated. It defines the switching hysteresis (for Controllers with an ON/OFF control output - primary or secondary output). The decimal point position = 1 decimal place.

4.4.7.5 **OVERLAP/DEADBAND** - *Word Parameter 16*

Applicable to a dual control output instrument only, this word parameter may be modified/interrogated. It may be set to positive and negative values (a positive value indicates overlap, a negative value indicates deadband). The decimal point position = 0 decimal places.

4.4.7.6 **PROPORTIONAL BAND 1 VALUE** - *Word Parameter 6*

This word parameter may be modified/interrogated. This may be set to 0.0 (for On/Off control) or to a value in the range 0.5% - 999.9% of Output 1 power range. The decimal point position is set to 1 decimal place.

4.4.7.7 **PROPORTIONAL BAND 2 VALUE** - *Word Parameter 5*

For a dual control output instrument, this word parameter may be modified/interrogated. This may be set to 0.0 (for On/Off control) or to a value in the range 0.5% - 999.9% of Output 2 power range. The decimal point position is set to 1.

4.4.8 **Status Parameters**

4.4.8.1 **STATUS** - *Word Parameter 7*

This Read Only word parameter comprises all 16 bit parameters (see Table 4-1)

4.4.8.2 **ARITHMETIC DEVIATION (PROCESS VARIABLE - SETPOINT) VALUE** - *Word Parameter 4*

This Read Only word parameter is the difference between the current process variable value and the current setpoint value at the instant the message is received.

4.4.8.3 **AM KEY USAGE** - *Word Parameter 34*

This Read Only word parameter indicates the current usage selected for the front panel **AM** key:

- 0 - Output Turnoff
- 1 - Auto/Manual Control selection
- 2 - Heater Current display

See also Subsection 3.2.37.

5 ASCII COMMUNICATIONS

The Plastics Controller may be equipped with a two-wire RS485-compatible serial communications facility, by which means communication may occur between the Controller and a master device (e.g. a computer or terminal).

5.1 COMMUNICATIONS WRITE ENABLE/DISABLE

When Communication Writes are enabled (in Set Up Mode - see Subsection 3.2.39), the Controller parameters may be adjusted by the master device via the serial communications link. If communications Writes are disabled, the Controller will not adjust or change any parameters in response to commands received from the master device and will send a negative acknowledgement in response to such commands. Whether communications Writes are enabled or disabled, the Controller will return the requested information in response to a Type 2 Interrogation message (see Subsection 5.2.5) from the master device.

5.2 PHYSICAL REQUIREMENTS

5.2.1 Character Transmission

Data format is fixed to be even parity, one start bit, seven data bits and one stop bit. The Baud rate may be selected to be 1200, 2400, 4800 (default) or 9600 Baud.

5.2.2 Line Turn-Round

The communications link is operated as a multi-drop half duplex system. When a device is transmitting, it drives the transmission lines to the appropriate levels; when it is not transmitting, its outputs are set to a high impedance in order that another device can transmit. It is important that a transmitter releases the transmission lines before another device starts transmission. This imposes the following restraints on the master device:

- (a) The transmitter must release the transmission lines within 6ms of the end of the last character of a message being transmitted. Note that delays due to buffers such as those used in universal asynchronous receivers/transmitters (UARTs) within the master device must be taken into account.
- (b) The transmitter must not start transmission until 6ms has elapsed since the reception of the last character of a message.

All Plastics Controllers having an RS485 communications facility adhere to this standard; thus, provided that the master device conforms similarly to the standard, there should be no line contention problems.

5.2.3 ASCII Protocol

The protocol assumes half duplex communications. All communication is initiated by the master device. The master sends a command or query to the addressed slave and the slave replies with an acknowledgement of the command or the reply to the query. All messages, in either direction, comprise:

- (a) A Start of Message character
- (b) One or two address characters (uniquely defining the slave)
- (c) A parameter/data character string
- (d) An End of Message character

Messages from the master device may be one of four types:

- Type 1:** L {N} ? ? *
- Type 2:** L {N} {P} {C} *
- Type 3:** L {N} {P} # {DATA} *
- Type 4:** L {N} {P} I *

where all characters are in ASCII code and:

- L is the Start of Message character (Hex 4C)
- {N} is the slave Controller address (in the range 1 - 99); addresses 1 - 9 may be represented by a single digit (e.g. 7) or in two-digit form, the first digit being zero (e.g. 07).
- {P} is a character which identifies the parameter to be interrogated/modified - see Table 5-2.
- {C} is the command (see below)
- # indicates that {DATA} is to follow (Hex 23)
- {DATA} is a string of numerical data in ASCII code (see Table 5-1)
- * is the End of Message character (Hex 2A)

No space characters are permitted in messages. Any syntax errors in a received message will cause the slave controller to issue no reply and await the Start of Message character.

5.2.4 Type 1 Message

$$L \{N\} \ ? \ ? \ ? \ *$$

This message is used by the master device to determine whether the addressed slave Controller is active. The reply from the slave Controller, if it is active, is

$$L \{N\} \ ? \ A \ *$$

An inactive Controller will give no reply.

5.2.5 Type 2 Message

$$L \{N\} \ \{P\} \ \{C\} \ *$$

This type of message is used by the master device to interrogate or modify a parameter in the addressed Controller. {P} identifies the parameter (as defined in Table 5-2) and {C} represents the command to be executed, which may be one of the following:

- + (Hex 2B) - Increment the value of the parameter defined by {P}
- (Hex 2D) - Decrement the value of the parameter defined by {P}
- ? (Hex 3F) - Determine the current value of the parameter defined by {P}

The reply from the addressed Controller is of the form:

$$L \{N\} \ \{P\} \ \{DATA\} \ A \ *$$

where {DATA} comprises five ASCII-coded digits whose format is shown in Table 5-1. The data is the value requested in a query message or the new value of the parameter after modification. If the action requested by the message from the master device would result in an invalid value for that parameter (either because the requested new value would be outside the permitted range for that parameter or because the parameter is not modifiable), the Controller replies with a negative acknowledgement:

$$L \{N\} \ \{P\} \ \{DATA\} \ N \ *$$

The {DATA} string in the negative acknowledgement reply will be indeterminate. If the process variable or the deviation is interrogated whilst the process variable is outside the range of the Controller, the reply is:

$$L \{N\} \ \{P\} \ < \ ? \ ? \ > \ 0 \ A \ *$$

if the process variable is over-range, or

$$L \{N\} \ \{P\} \ < \ ? \ ? \ > \ 5 \ A \ *$$

if the process variable is under-range.

Scan Tables

A parameter identifier character “]” in the message from the master device indicates that a “Scan Table” operation is required. This provides a facility for interrogating the values of a group of parameters and status in a single message from the master device. The reply to such a command would be in the form:

$$L \{N\}] xx aaaaa bbbbb ccccc ddddd eeeee A *$$

where xx is the number of data digits to follow; this is 20 for a single-control-output instrument and 25 for a dual-control-output instrument. The digits are expressed as shown in Table 5-1. For further information, refer to Subsection 5.3.8.4.

5.2.6 Type 3 Message

$$L \{N\} \{P\} \# \{DATA\} *$$

This message type is used by the master device to set a parameter to the value specified in {DATA}. The command is not implemented immediately by the slave Controller; the slave will receive this command and will then wait for a Type 4 message (see below). Upon receipt of a Type 3 message, if the {DATA} content and the specified parameter are valid, the slave Controller reply is of the form:

$$L \{N\} \{P\} \{DATA\} I *$$

(where I = Hex 49) indicating that the Controller is ready to implement the command. If the parameter specified is invalid or is not modifiable or if the desired value is outside the permitted range for that parameter, the Controller replies with a negative acknowledgement in the form:

$$L \{N\} \{P\} \{DATA\} N *$$

5.2.7 Type 4 Message

$$L \{N\} \{P\} I *$$

This type of message is sent by the master device to the addressed slave Controller following a successful Type 3 message transmission and reply to/from the same slave Controller. Provided that the {DATA} content and the parameter specified in the preceding Type 3 message are still valid, the slave Controller will then set the parameter to the desired value and will reply in the form:

$$L \{N\} \{P\} \{DATA\} A *$$

where {DATA} is the new value of the parameter. If the new value or parameter specified is invalid, the slave Controller will reply with a negative acknowledgement in the form:

L {N} {P} {DATA} N *

where {DATA} is indeterminate. If the immediately-preceding message received by the slave Controller was not a Type 3 message, the Type 4 message is ignored.

Table 5-1 {DATA} Element - Sign and decimal Point Position

{DATA} Content	Sign/Decimal Point Position	{DATA} Content	Sign/Decimal Point Position
abcd0	+abcd	abcd5	-abcd
abcd1	+abc.d	abcd6	-abc.d
abcd2	+ab.cd	abcd7	-ab.cd

Table 5-2 Commands/Parameters and Identifiers

Identifier	Parameter/Command	Identifier	Parameter/Command
A	Setpoint High Limit	W	Output Power (Read Only if not in Manual Control)
B	Output 1 Power Limit	Z	Controller Commands ³
C	Alarm 1 value	[Recorder Output Scale Max.
D	Rate (Derivative Time Constant) ¹	\	Recorder Output Scale Min.
E	Alarm 2 value]	Scan Table
F	ON/OFF Differential	^	Setpoint Ramp Rate
G	Scale Range Max. (Read Only)	a	Alarm 1 Hysteresis value
H	Scale Range Min. (Read Only)	b	Alarm 2 Hysteresis value
I	Reset (Integral Time Constant) ¹	c	Heater Current High Scale Limit
J	Manual Reset (Bias)	d	Heater Current Nominal Value
K	Overlap/Deadband	e	Heater Current (Read Only)
L	Controller Status ²	f	High Heater Break Alarm value
M	Process Variable	g	Low Heater Break Alarm value
N	Output 1 Cycle Time	h	AM Key Usage (Read Only)
O	Output 2 Cycle Time	i	Control Setpoint value (Read Only)
P	Proportional Band 1 ¹	j	Soft Start Setpoint value
Q	Scale Range Decimal Point Position (Read Only)	k	Soft Start Time value
S	Setpoint value	l	Soft Start Time Remaining (Read Only)
T	Setpoint Low Limit	m	Input Filter Time Constant
U	Proportional Band 2 ¹	v	Process Variable Offset value
V	Deviation value		

NOTES ON TABLE 5-2

1. These parameters cannot be modified whilst either the Pre-Tune facility or the Self-Tune facility is activated.

2. The Controller Status byte has the following format:

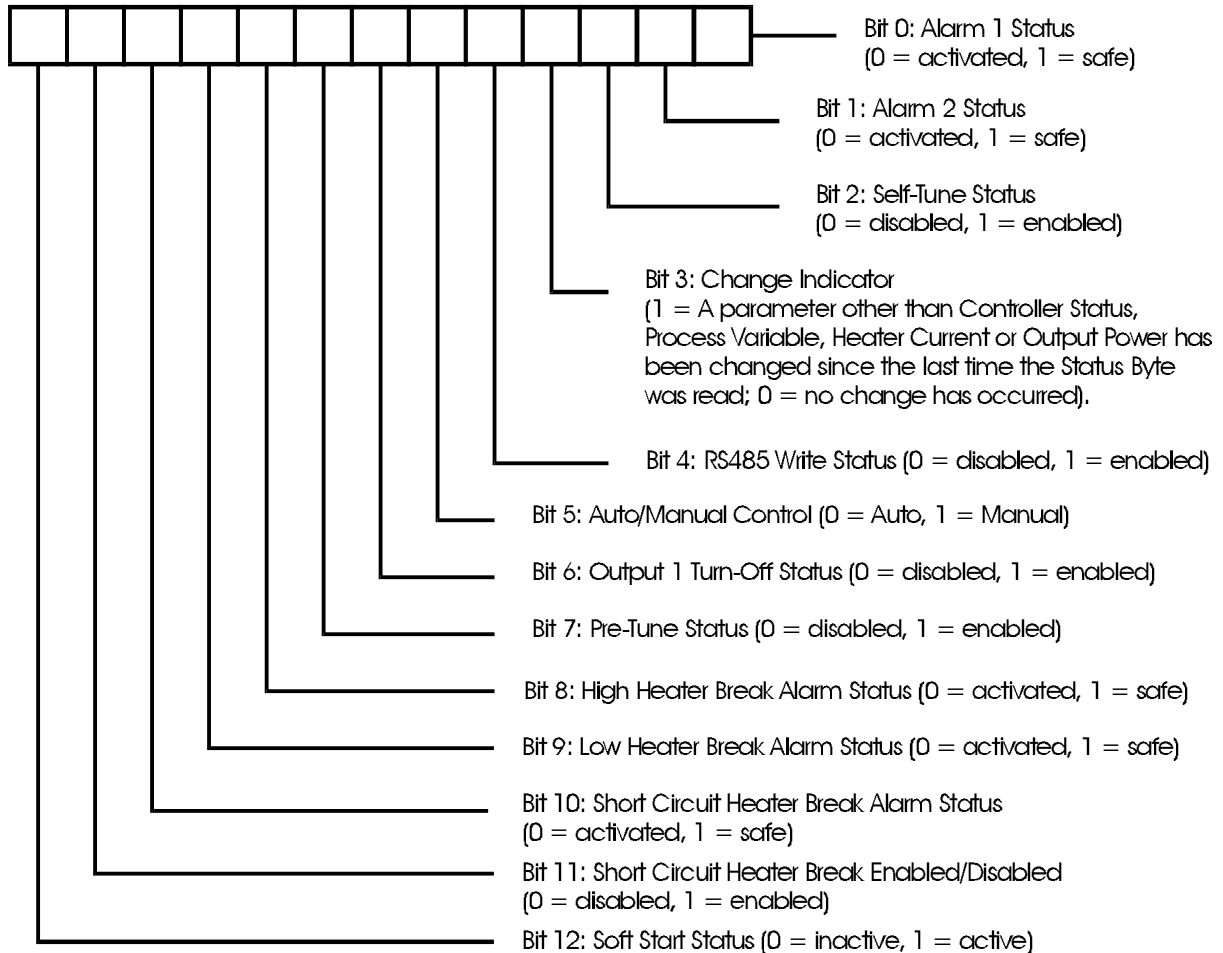

3. Only Type 3 or Type 4 messages are allowed with this parameter. In the Type 3 message, the {DATA} field must be one of eleven five-digit numbers. The reply from the Controller also contains the {DATA} field with the same content. When the master device issues the Type 4 message, the Controller responds with the same {DATA} field content. The commands corresponding to the {DATA} field value are:

00010	=	Activate Manual Control ¹
00020	=	Activate Automatic Control ¹
00030	=	Activate the Self-Tune facility
00040	=	De-activate the Self-Tune Facility
00050	=	Request Pre-Tune ²
00060	=	Abort Pre-Tune
00150	=	Activate Output Turn-Off ³
00160	=	De-activate Output Turn-Off ³

NOTES ON TABLE 5-2 (Cont.)

00170 = Enable Short Circuit Heater Break Alarm ⁴00180 = Disable Short Circuit Heater Break Alarm ⁴00190 = Heater Nominal Current Quick Transfer ⁵

1. Only if **AM** Key Usage = **PoEn**
2. The Controller will go into Pre-Tune Mode only if the process variable is at least 5% of input span from the setpoint.
3. Only if **AM** Key Usage = **OoFF**.
4. Not applicable if Heater Break Input Type is configured to be **SCRi**.
5. Only available if Heater Break Alarm Strategy is set to Percentage Mode.

5.3 INDIVIDUAL PARAMETERS

Unless otherwise stated, the {DATA} element will follow the standard five-digit format and the decimal point position must be correct for the new value to be accepted and for modification to occur.

5.3.1 Input Parameters

5.3.1.1 PROCESS VARIABLE OR MEASURED VARIABLE {P} = M

This parameter may be interrogated only, using a Type 2 message. If the process variable is out of range, the five-digit {DATA} field in the reply will not contain a number, but will contain <??>0 (over-range) or <??>5 (under-range).

5.3.1.2 PROCESS VARIABLE OFFSET {P} = v

This parameter may be modified/interrogated using a Type 2 message or a Type 3/4 message sequence. It modifies the actual process variable value (as measured at the Controller's input terminals) in the following manner:

$$\text{Modified PV value} = \text{Actual PV value} + \text{process variable offset value}$$

The modified PV value is limited by Range Maximum and Range Minimum and is used for display and alarm purposes and for recorder outputs.

NOTE: This parameter value should be selected with care. Any adjustment to this parameter is, in effect, an adjustment to the Controller's calibration. Injudicious application of values to this

parameter could lead to the displayed PV value having no meaningful relationship to the actual PV value.

5.3.1.3 SCALE RANGE MAXIMUM $\{P\} = G$

This parameter may be interrogated only using a Type 2 message. The decimal point position is as for the input range.

5.3.1.4 SCALE RANGE MINIMUM $\{P\} = H$

This parameter may be interrogated only using a Type 2 message. The decimal point position is as for the input range.

5.3.1.5 SCALE RANGE DECIMAL POINT POSITION $\{P\} = Q$

This parameter may be interrogated only using a Type 2 message. The value of this parameter indicates the decimal point position (0 = abcd, 1 = abc.d).

5.3.1.6 INPUT FILTER TIME CONSTANT $\{P\} = m$

This parameter may be modified/interrogated using a Type 2 message or a Type 3/4 message sequence.

CAUTION: If this parameter is set to an excessively high value, the control quality may be significantly impaired. The value chosen should be sufficiently large to attenuate stray noise on the process variable signal but no larger.

5.3.2 Output Parameters

5.3.2.1 OUTPUT POWER VALUE $\{P\} = W$

The value of this parameter may range between 0% and 100% (for a single-output Controller) or -100% and 100% for a dual-output Controller. If Manual control is not selected, this parameter may be interrogated only using a Type 2 message; if Manual control is selected, this parameter may be adjusted using a Type 2 message or a Type 3/4 message sequence.

5.3.2.2 OUTPUT 1 POWER LIMIT $\{P\} = B$

This parameter may be modified/interrogated using a Type 2 message or a Type 3/4 message sequence. It defines the power limit for Universal Output 1 and may be set in the range 0% to 100% of full power. The default value is 100%. The decimal point position is set to 0. If Soft Start is used, this power limit is applicable only during Soft Start. When Soft Start is completed, Output 1 power can go to 100%.

5.3.2.3 OUTPUT 1 CYCLE TIME $\{P\} = N$

This parameter may be modified/interrogated using a Type 2 message or a Type 3/4 message sequence. The value to which this is set is dependent upon the output type and the nature of the process to be controlled. For relay outputs, this parameter should be set to as large a value as possible (consistent with satisfactory control of the process) in order that the life of the relay be maximised. For SSR Drive and Solid State outputs, lower values may be used. The decimal point position is set to 0 for all except the 0.5s value (00051).

NOTE: Cycle Time values must be written correctly if a Type 3/4 message sequence is used i.e. the value must be a power of 2 in the range 0.5 - 512 (0.5, 1, 2, 4, 8, etc.).

5.3.2.4 OUTPUT 2 CYCLE TIME $\{P\} = 0$

This parameter may be modified/interrogated using a Type 2 message or a Type 3/4 message sequence. The value to which this is set is dependent upon the output type and the nature of the process to be controlled. For relay outputs, this parameter should be set to as large a value as possible (consistent with satisfactory control of the process) in order that the life of the relay be maximised. For SSR Drive and Solid State outputs, lower values may be used. The decimal point position is set to 0 for all except the 0.5s value (00051).

NOTE: Cycle Time values must be written correctly if a Type 3/4 message sequence is used i.e. the value must be a power of 2 in the range 0.5 - 512 (0.5, 1, 2, 4, 8, etc.).

5.3.2.5 RECORDER OUTPUT SCALE MAXIMUM VALUE $\{P\} = [$

This parameter may be modified/interrogated using a Type 2 message or a Type 3/4 message sequence. It defines the maximum scale value for the Controller's Recorder Output and may be adjusted within the range -1999 to 9999. This value corresponds to the Input Scale Maximum and the decimal point position will always be the same as that for the input.

NOTE: If this parameter is set to a value less than the Recorder Output Minimum Value, the Recorder Output sense is reversed.

5.3.2.6 RECORDER OUTPUT SCALE MINIMUM VALUE $\{P\} = \backslash$

This parameter may be modified/interrogated using a Type 2 message or a Type 3/4 message sequence. It defines the minimum scale value for the Controller's Recorder Output and may be adjusted within the range -1999 to 9999. This value corresponds to the Input Scale Minimum and the decimal point position will always be the same as that for the input.

NOTE: If this parameter is set to a value greater than the Recorder Output Maximum Value, the Recorder Output sense is reversed.

5.3.3 Heater Current Parameters

5.3.3.1 HEATER CURRENT HIGH SCALE LIMIT $\{P\} = c$

This parameter defines the full scale value for the heater current range and may be modified/interrogated using a *Type 3/4 message sequence only*. It may be adjusted from 10.0A to 20.0A in 0.1A increments, and then from 21A to 100A in 1A increments. The default value is 50A. *Heater current range minimum is fixed at 0A.*

NOTE: If this parameter value is changed, the Heater Nominal Current, Low Heater Break Alarm Value and High Heater Break Alarm Value parameters are set to their default values.

5.3.3.2 HEATER NOMINAL CURRENT $\{P\} = d$

This parameter defines a nominal value for the heater current and may be modified/interrogated using a Type 2 message or a Type 3/4 message sequence. It may be adjusted in the range 0A to Heater Current High Scale Limit value. The default value is the Heater Current High Scale Limit value. *This parameter is accessible only if Heater Break Alarm Strategy is set to Percentage Mode.*

5.3.3.3 HEATER ACTUAL CURRENT $\{P\} = e$

This parameter indicates the most recent valid heater current value at the instant the message is received; it is equivalent to calling up the heater current display from the front panel. This parameter may be interrogated only using a Type 2 message.

5.3.4 Setpoint Parameters

5.3.4.1 SETPOINT VALUE $\{P\} = S$

This parameter may be modified/interrogated using a Type 2 message or a Type 3/4 message sequence. It can be set to any value between Setpoint High Limit (see Subsection 5.3.4.3) and Setpoint Low Limit (see Subsection 5.3.4.4).

5.3.4.2 SETPOINT RAMP RATE $\{P\} = \wedge$

This parameter may be modified/interrogated using a Type 2 message or a Type 3/4 message sequence. It defines the rate at which the current setpoint can be made to ramp and can be set to a value in the range 1 - 9999 increments per hour. If it is desired to switch setpoint ramping OFF, a Type 3/4 message sequence should be used in which the $\{DATA\}$ element of the Type 3 message should be set to 0000. If setpoint ramping is OFF, the $\{DATA\}$ element in the response to an interrogation will be set to 0000. The decimal point position is as for the input range.

5.3.4.3 SETPOINT HIGH LIMIT $\{P\} = A$

This parameter may be modified/interrogated using a Type 2 message or a Type 3/4 message sequence. It defines the maximum value which may be assigned to the setpoint. The default value is Input Range Maximum. The permissible range is between the current setpoint value and Input Range Maximum. The decimal point position is as for the input range.

5.3.4.4 SETPOINT LOW LIMIT $\{P\} = T$

This parameter may be modified/interrogated using a Type 2 message or a Type 3/4 message sequence. It defines the minimum value which may be assigned to the setpoint. The default value is Input Range Minimum. It may be set to a value between Input Range Minimum and the current value of the setpoint. The decimal point position is as for the input range.

5.3.4.5 CONTROL SETPOINT $\{P\} = i$

This parameter, which may be interrogated only using a Type 2 message, is the setpoint value being used by the Controller *at the instant the message is received*. When the setpoint is ramping, this is the current value.

5.3.5 Soft Start Parameters

5.3.5.1 SOFT START SETPOINT $\{P\} = j$

This parameter may be modified/interrogated using a Type 2 message or a Type 3/4 message sequence. It defines the value of setpoint to be used during a Soft Start. It may be adjusted between Input Range Minimum and Input Range Maximum. The default value is Input Range Minimum.

5.3.5.2 SOFT START TIME $\{P\} = k$

This parameter may be modified/interrogated using a Type 2 message or a Type 3/4 message sequence. It defines the duration of the Soft Start. It may be adjusted in 15-second increments within the range 0 (OFF) to 59 minutes 45 seconds. A value which is not an exact multiple of 15 seconds is treated as an invalid value. The default value is 0 (OFF).

5.3.5.3 SOFT START TIME REMAINING $\{P\} = l$

This parameter, which may be interrogated only using a Type 2 message, is the time remaining for a Soft Start *at the instant the message is received*. When there is no Soft Start currently in effect, a value of 0 is returned.

5.3.6 Alarm Parameters

5.3.6.1 ALARM 1 VALUE $\{P\} = C$

This parameter may be modified/interrogated using a Type 2 message or a Type 3/4 message sequence. It defines the level at which Alarm 1 will go active. The decimal point position is as for the input range.

5.3.6.2 ALARM 1 HYSTERESIS $\{P\} = a$

This parameter, which may be modified/interrogated using a Type 2 message or a Type 3/4 message sequence, applies a hysteresis band on the “safe” side of the Alarm 1 value. Thus, Alarm 1 will become active when the Alarm 1 value is exceeded; Alarm 1 will become inactive when the process variable value is outside the hysteresis band on the “safe” side of the Alarm 1 value. Alarm 1 Hysteresis may be set to a value in the range 1 - 250 or 0.1 - 25.0 (as per Heater Current High Scale Limit). The effect of the hysteresis value on the operation of the different types of alarm is illustrated in Figure 3-3.

5.3.6.3 ALARM 2 VALUE $\{P\} = E$

This parameter may be modified/interrogated using a Type 2 message or a Type 3/4 message sequence. It defines the level at which Alarm 2 will go active. The decimal point position is as for the input range.

5.3.6.4 ALARM 2 HYSTERESIS $\{P\} = b$

This parameter, which may be modified/interrogated using a Type 2 message or a Type 3/4 message sequence, applies a hysteresis band on the “safe” side of the Alarm 2 value. Thus, Alarm 2 will become active when the Alarm 2 value is exceeded; Alarm 2 will become inactive when the process variable value is outside the hysteresis band on the “safe” side of the Alarm 2 value. Alarm 2 Hysteresis may be set to a value in the range 1 - 250 or 0.1 - 25.0 (as per Heater Current High Scale Limit). The effect of the hysteresis value on the operation of the different types of alarm is illustrated in Figure 3-3.

5.3.6.5 LOW HEATER BREAK ALARM VALUE $\{P\} = g$

This parameter, which may be modified/interrogated using a Type 2 message or a Type 3/4 message sequence, defines a heater current value below which the Low Heater Break Alarm will become active. It may be adjusted in the following ranges below the Heater Nominal Current:

If Heater Break Alarm Strategy = Percentage Mode: 0 - 100% of Heater Nominal Current (0 = OFF - value display blank, Low Heater Alarm forced inactive). Default value = 20% below heater nominal current. Hysteresis is half the Low Heater Break Alarm value.

If Heater Break Alarm Strategy = Absolute Mode: 0.1A/1A
 (dependent upon display resolution) - Heater Current High Scale Limit and 0 (OFF) - value display blank, Low Heater Alarm forced inactive. Default value = 0 (OFF). Hysteresis is 0.5A for 0.1A resolution and 2A for 1A resolution.

5.3.6.6 HIGH HEATER BREAK ALARM VALUE $\{P\} = f$

This parameter, which may be modified/interrogated using a Type 2 message or a Type 3/4 message sequence, defines a heater current value above which the High Heater Break Alarm will become active. It may be adjusted in the following ranges above the Heater Nominal Current:

If Heater Break Alarm Strategy = Percentage Mode: 0 - 100% of Heater Nominal Current (0 = OFF - value display blank, High Heater Break Alarm forced inactive). Default value = 0 (OFF). Hysteresis is half the High Heater Break Alarm value. NOTE: Unless the High Heater Break Alarm is set OFF, if the heater current exceeds the Heater Current High Scale Limit, the High Heater Break Alarm will be forced active, even if the High Heater Break Alarm level is set higher than the Heater Current High Scale Limit.

If Heater Break Alarm Strategy = Absolute Mode: 0.1A/1A
 (dependent upon display resolution) - Heater Current High Scale Limit and 0 (OFF) - value display blank, High Heater Break Alarm forced inactive. Default value = 0 (OFF). Hysteresis is 0.5A for 0.1A resolution and 2A for 1A resolution.

5.3.7 Tuning Parameters

5.3.7.1 RATE (DERIVATIVE TIME CONSTANT) $\{P\} = D$

This parameter may be modified/interrogated using a Type 2 message or a Type 3/4 message sequence. It defines the derivative time constant for the control algorithm. The {DATA} element is in a format in which the first two digits represent minutes and the second two digits represent seconds. The decimal point is used as the separator between the minutes and seconds digits (i.e. set to 2 decimal places); the decimal point position must be as described, otherwise modification will not occur.

5.3.7.2 RESET (INTEGRAL TIME CONSTANT) $\{P\} = I$

This parameter may be modified/interrogated using a Type 2 message or a Type 3/4 message sequence. The {DATA} element is in a format in which the first two digits represent minutes and the second two digits represent seconds. The decimal point position complies with this format and the decimal point is used as a separator between the minutes digits and the seconds digits. The decimal point must be in the correct position for modification to occur.

5.3.7.3 MANUAL RESET (BIAS) $\{P\} = J$

This parameter may be modified/interrogated using a Type 2 message or a Type 3/4 message sequence. The decimal point position is as for the input range.

5.3.7.4 ON/OFF DIFFERENTIAL $\{P\} = F$

This parameter may be modified/interrogated using a Type 2 message or a Type 3/4 message sequence. It defines the switching hysteresis (for Controllers with an ON/OFF control output - primary or secondary output). The decimal point position = 1.

5.3.7.5 OVERLAP/DEADBAND $\{P\} = K$

Applicable to a dual control output instrument only, this parameter may be modified/interrogated using a Type 2 message or a Type 3/4 message sequence. It may be set to positive and negative values (a positive value indicates overlap, a negative value indicates deadband). The decimal point position = 0.

5.3.7.6 PROPORTIONAL BAND 1 VALUE $\{P\} = P$

This parameter may be modified/interrogated using a Type 2 message or a Type 3/4 message sequence. This may be set to 0.0 (for On/Off control) or to a value in the range 0.5% - 999.9% of Output 1 power range. The decimal point position is set to 1.

5.3.7.7 PROPORTIONAL BAND 2 VALUE $\{P\} = U$

For a dual control output instrument, this parameter may be modified/interrogated using a Type 2 message or a Type 3/4 message sequence. This may be set to 0.0 (for On/Off control) or to a value in the range 0.5% - 999.9% of Output 2 power range. The decimal point position is set to 1.

5.3.8 Status Parameters

5.3.8.1 CONTROLLER STATUS $\{P\} = L$

This parameter may be interrogated only, using a Type 2 message. The status information is encoded in the four digits as the decimal representation of a binary number. Each bit in the binary number has a particular significance (see NOTES ON TABLE 5-2).

5.3.8.2 ARITHMETIC DEVIATION (PROCESS VARIABLE - SETPOINT) VALUE $\{P\} = V$

This parameter may be interrogated only, using a Type 2 message. It is the difference between the current process variable value and the current setpoint value.

5.3.8.3 AM KEY USAGE {P} = h

This parameter, which may be interrogated only using a Type 2 message, indicates the usage selected for the front panel **AM** key:

- 0 - Output Turnoff
- 1 - Auto/Manual Control selection
- 2 - Heater Current display

See also Subsection 3.2.37.

5.3.8.4 SCAN TABLE {P} =]

The Scan Table operation takes the form of a Type 2 interrogation command which accesses a set of information (held in the {DATA} element in the response). The response would be in the form:

L {N}] xx aaaaa bbbbb ccccc ddddd eeeee A *

where xx is the number of data digits in the {DATA} element to follow; this is 20 for a single-control-output instrument and 25 for a dual-control-output instrument. These digits are as described in Table 5-2 and may comprise:

aaaaa	The current setpoint value
bbbbb	The current process variable value
ccccc	The current value of Output 1 Power (0 - 100%)
dddd	The current value of Output 2 Power (0 - 100%), if applicable.
eeee	The Controller Status (see Note 2 on Table 5-2).

5.4 ERROR RESPONSE

The circumstances under which a received message is ignored are:

- Parity error detected
- Syntax error detected
- Timeout elapsed
- Receipt of a Type 4 message without a preceding Type 3 message.

Negative acknowledgements will be returned if, in spite of the received message being notionally correct, the Controller cannot supply the requested information or perform the requested operation. The {DATA} element of a negative acknowledgement will be indeterminate.

ALPHABETICAL INDEX - VOLUME 1

A

- Active Alarm
 - Indication of 2-4
- Active Setpoint
 - Indication of 2-3
- Address Range
 - ASCII protocol 5-2
- Address Range - Enhanced RS485 Option
 - MODBUS RTU protocol 4-5
- Address Range - Standard RS485 Option
 - MODBUS RTU protocol 4-5
- Alarm 1 Hysteresis 3-12, 4-14, 5-12
- Alarm 1 Value 4-14, 5-12
- Alarm 2 Hysteresis 3-14, 4-14, 5-12
- Alarm 2 Value 4-14, 5-12
- Alarm Status
 - Display of 2-4
- Alarms
 - Summary description 1-4
- AM** Key Usage 3-16, 4-16, 5-15
 - To select automatic control/output turn-off 2-5
 - To select automatic/manual control 2-5
 - To select heater current display 2-5
- Arithmetic Deviation 4-16
- Arithmetic Deviation Value 5-14
- ASCII Communications Protocol 5-1
- Auto Pre-Tune Enable/Disable 3-16
- Automatic Tuning 1-3

B

- Band Alarm 1 3-10
- Band Alarm 2 3-12
- Baud Rate
 - ASCII protocol 5-1
 - MODBUS protocol 4-1

- Bias 4-15, 5-14
 - See Also Manual Reset
- Broadcast Messages
 - MODBUS RTU protocol 4-2
- Bumpless Transfer 1-3, 2-5

C

- Character Transmission
 - ASCII protocol 5-1
 - MODBUS RTU protocol 4-1
- Communications
 - MODBUS bit parameters 4-6
 - MODBUS word parameters 4-6
- Communications Data Format
 - ASCII protocol 5-1
 - MODBUS RTU protocol 4-1
- Communications Line Release Time
 - Maximum Value 5-1
- Communications Message Format 5-2
- Configuration Mode
 - Summary description 1-2
- Control
 - Summary description 1-3
- Control Setpoint 5-11
- Controller Address
 - MODBUS RTU message format 4-2
- Controller Status 4-16
 - ASCII Protocol 5-6, 5-14
 - MODBUS RTU protocol 4-4
- Cycle Time
 - Definition of 1-3
- Cyclic Redundancy Checksum
 - Description of 4-2
- Cyclic Redundancy Checksum (CRC)
 - Description of 4-2

D

Data Padding	4-4
Deadband	3-8, 4-16, 5-14
Decimal Point Position	4-10
Derivative Time Constant	4-15, 5-13
Derivative Time Constant	See Also Rate
Deviation Alarm 1	3-12
Deviation Alarm 2	3-14

E

Error Responses	
ASCII protocol	5-15
MODBUS RTU protocol	4-5
Exception Responses	
MODBUS RTU protocol	4-5

F

Front Panel Keys	
Illustration of	2-1
Function Number	
MODBUS RTU message format	4-2

H

Hardware Definition Code	
Display of (Operator Mode)	2-8
Explanation of	2-8
Hardware Definition Code	
Automatic cancellation of display	2-8
Heater Actual Current	4-12, 5-10
Heater Break Alarms	
Use of	1-4
Heater Current	
Quick Transfer to nominal value	2-6
Heater Current Control	
Summary description	1-3

Heater Current Display	
Selection of (Operator Mode)	2-5
Selection/de-selection	2-5
Heater Current High Scale Limit	3-14, 4-12, 5-10
Heater Nominal Current	3-14, 4-12, 5-10
Heater Nominal Current	
Automatic setting to default	3-14
High Heater Break Alarm	3-15
Automatic setting to default	3-14
High Heater Break Alarm Value	4-15, 5-13
Hysteresis	
See Also ON/OFF Differential	

I

Inactive Setpoint	
Indication of	2-3
Indicators	
Illustration of	2-1
Input Filter Time Constant	3-5, 4-10, 5-8
Input Over-Range	
Indication of	2-4
Input Type	
Indication of (Operator Mode)	2-8
Integral Time Constant	4-15, 5-13
Integral Time Constant	
See Also Reset	
Internal Setpoint	4-13

J

JBUS Function Names	4-1
---------------------	-----

L

Line Turn-Round	
ASCII protocol	5-1
MODBUS RTU protocol	4-1
Lock Value	3-17
Low Heater Break Alarm	3-14
Automatic setting to default	3-14
Low Heater Break Alarm Value	4-14, 5-12

M

Manual Control Mode	
Description of operation	2-5
Manual Control Mode	
Selection of	2-5
Manual Reset	4-15, 5-14
See Also Bias	
Manual Tuning	
Controllers with Output 1 and Output 2	3-19
Controllers with Output 1 only	3-18
Dual output	3-19
Single Output	3-18
Message Formats	
MODBUS RTU protocol	4-2
MODBUS Functions Supported	4-1
MODBUS RTU Protocol	4-1
Multi-Word Write Function	
MODBUS protocol	4-1

O

ON/OFF Differential	5-14
See Also Hysteresis	
Operator Mode	
Summary description	1-3
Output 1	
Use of	1-3
Output 1 Cycle Time	3-9, 4-11, 5-9

Output 1 Power Limit	3-9, 4-11, 5-8
Output 2	
Use of	1-3
Output 2 Cycle Time	3-10 - 4-11, 5-9
Output Power 1	3-6
Output Power 2	3-6
Output Power Value	4-10, 5-8
Output Turn Off	
Description of operation	2-5
Output Turn-Off	
Selection of	2-5
Output Type	
Indication of (Operator Mode)	2-8
Overlap	3-8, 4-16, 5-14

P

Parameter Adjustment	
Operator Mode	2-3
Parameter List	
ASCII Protocol	5-5
Parameter Selection	
Operator Mode	2-1
Parity	
ASCII protocol	5-1
MODBUS RTU protocol	4-1
PID Control	1-3
Pre-Tune	
Dis-engagement of	2-7
Pre-Tune Active	
Indication of	2-7
Pre-Tune Facility	
Activation of	2-7
Process High Alarm 1	3-10
Process High Alarm 2	3-12
Process Low Alarm 1	3-10
Process Low Alarm 2	3-12
Process Variable	4-9, 5-7
Definition of	1-3
Process Variable Offset	3-5, 4-10, 5-7

Proportional Band 1	3-6		
Proportional Band 1 Value	4-16,		
5-14			
Proportional Band 2	3-6		
Proportional Band 2 Value	4-16,		
5-14			
Q			
Quick Transfer			
Heater current to			
nominal value	2-6		
R			
Rate	4-15, 5-13		
See Also Derivative Time Constant			
Recorder Output Maximum			
Value	4-11		
Recorder Output Minimum			
Value	4-12		
Recorder Output Scale			
Maximum	3-9, 5-9		
Recorder Output Scale			
Minimum	3-9, 5-9		
Reset	4-15, 5-13		
See Also Integral Time Constant			
RS485 Communications	4-1		
RS485 Loading Limits	4-5		
RTU Form			
MODBUS protocol	4-2		
S			
Scale Range Decimal Point			
Position	5-8		
Scale Range Maximum	4-10, 5-8		
Scale Range Minimum	4-10, 5-8		
Scan Table Command	5-15		
Security Protection			
Configuration Mode	1-2		
Self-Tune			
Activation of	2-7		
Dis-engagement of	2-7		
Sensor Break			
Indication of	2-5		
Serial Communications	4-1		
Enabling/disabling	3-17		
End of Message			
character	5-2		
Message Types	5-2		
Scan Tables command	5-4		
Start of Message			
character	5-2		
Type 2 message	5-3		
Type 3 message	5-4		
Type 4 message	5-4		
Set Up Mode			
Automatic exit from	3-20		
Entry into	3-1		
Exit from	3-20		
Summary description	1-2		
Set Up Parameters at Default			
Indication of	3-1		
Setpoint			
Definition of	1-3		
Setpoint High Limit	3-8, 4-13, 5-11		
Setpoint Low Limit	3-8, 4-13, 5-11		
Setpoint Ramp Rate	4-12, 5-10		
Setpoint Ramping			
Enabling/disabling	3-16		
Setpoint Strategy			
Selection of	3-17		
Setpoint Value	4-12, 5-10		
Short Circuit Heater Break Alarm			
Enabling/disabling	3-15		
Soft Start			
Introduction to	2-3		
Summary description	1-3		
Soft Start in Progress			
Indication of	2-6		
Soft Start Setpoint	4-13, 5-11		
Adjustment of	3-15		
Summary description	1-3		
Soft Start Time	4-13, 5-11		
Adjustment of	3-16		
Summary description	1-3		

Soft Start Time remaining	4-13
Soft Start Time Remaining	5-11

T

Thermal shocks	
Avoidance of	1-3
Three-Term Control	1-3
Time-Proportioning	1-3
Two-wire Communications	4-1

W

Write Operations	
MODBUS RTU protocol	4-1

$\frac{1}{8}$ -DIN & $\frac{1}{16}$ -DIN PLASTICS CONTROLLERS

PRODUCT MANUAL

VOLUME 2 INSTALLATION & CONFIGURATION INSTRUCTIONS

The procedures described in this Volume must be undertaken only by technically-competent servicing personnel.

Contents - Volume 2

1	INSTALLATION	1-1
1.1	UNPACKING PROCEDURE	1-1
1.2	PANEL-MOUNTING THE CONTROLLER	1-1
1.3	CONNECTIONS AND WIRING	1-3
2	INTERNAL LINKS AND SWITCHES	2-1
2.1	REMOVING THE CONTROLLER FROM ITS HOUSING	2-1
2.2	REMOVING/REPLACING THE OUTPUT 2/OUTPUT 3 OPTION PCBs	2-3
2.3	REMOVING/REPLACING THE RS485 OPTION PCB OR DUAL SETPOINT/REMOTE HEATER CURRENT TRANSFER OPTION PCB	2-3
2.4	REPLACING THE CONTROLLER IN ITS HOUSING	2-4
2.5	SELECTION OF OUTPUT 1 TYPE	2-4
2.6	OUTPUT 2 TYPE/OUTPUT 3 TYPE	2-5
3	CONFIGURATION MODE	3-1
3.1	ENTRY INTO CONFIGURATION MODE	3-1

1 INSTALLATION

1.1 UNPACKING PROCEDURE

1. Remove the Controller from its packing. The Controller is supplied with a panel gasket and push-fit fixing strap. Retain the packing for future use, should it be necessary to transport the Controller to a different site or to return it to the supplier for repair/testing.

2. Examine the delivered items for damage or deficiencies. If any is found, notify the carrier immediately.

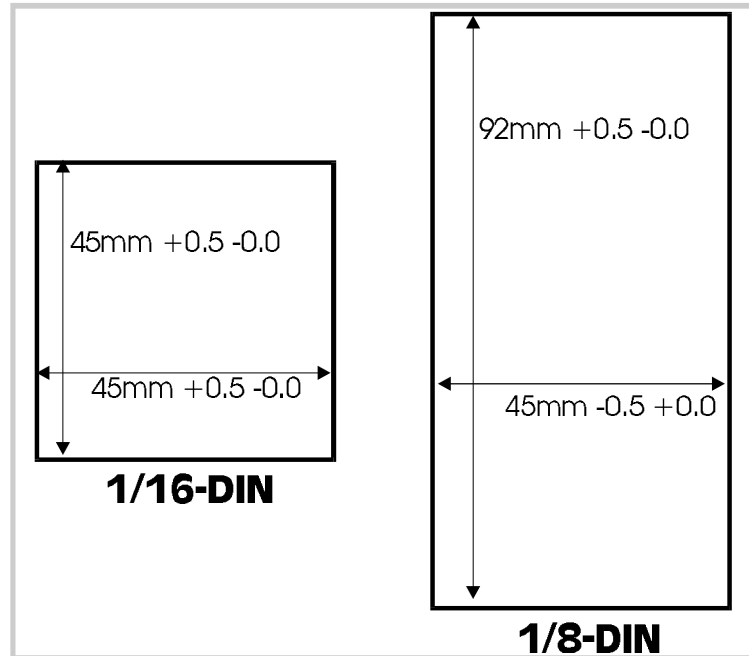

Figure 1-1 Cut-out Dimensions

1.2 PANEL-MOUNTING THE CONTROLLER

The panel on which the Controller is to be mounted must be rigid and may be up to 6.0mm (0.25 inches) thick. The cut-out required for a single Controller is as shown in Figure 1-1.

Several controllers may be installed in a single cut-out, side-by-side. For n Controllers mounted side-by-side, the width of the cut-out would be:

$$(48n - 4) \text{ millimetres or } (3.78n - 0.16) \text{ inches}$$

The Controller is 110mm deep (measured from the rear face of the front panel). When panel-mounted, the front panel projects 10mm from the mounting panel. The main dimensions of the Controller are shown in Figure 1-2.

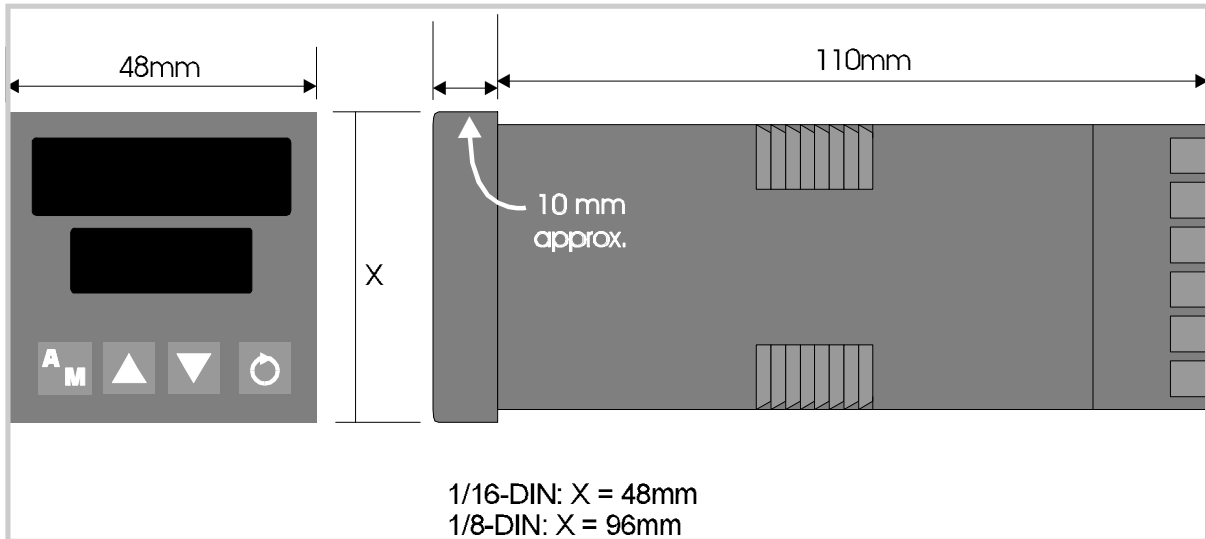

Figure 1-2 Main Dimensions

To panel-mount the Controller, proceed as shown in Figure 1-3. **NOTE:** Do not remove the panel gasket, as this may result in inadequate clamping of the instrument in the panel. Once the Controller is installed in its mounting panel, it may be subsequently removed from its housing, if necessary, as described in Subsection 2.1.

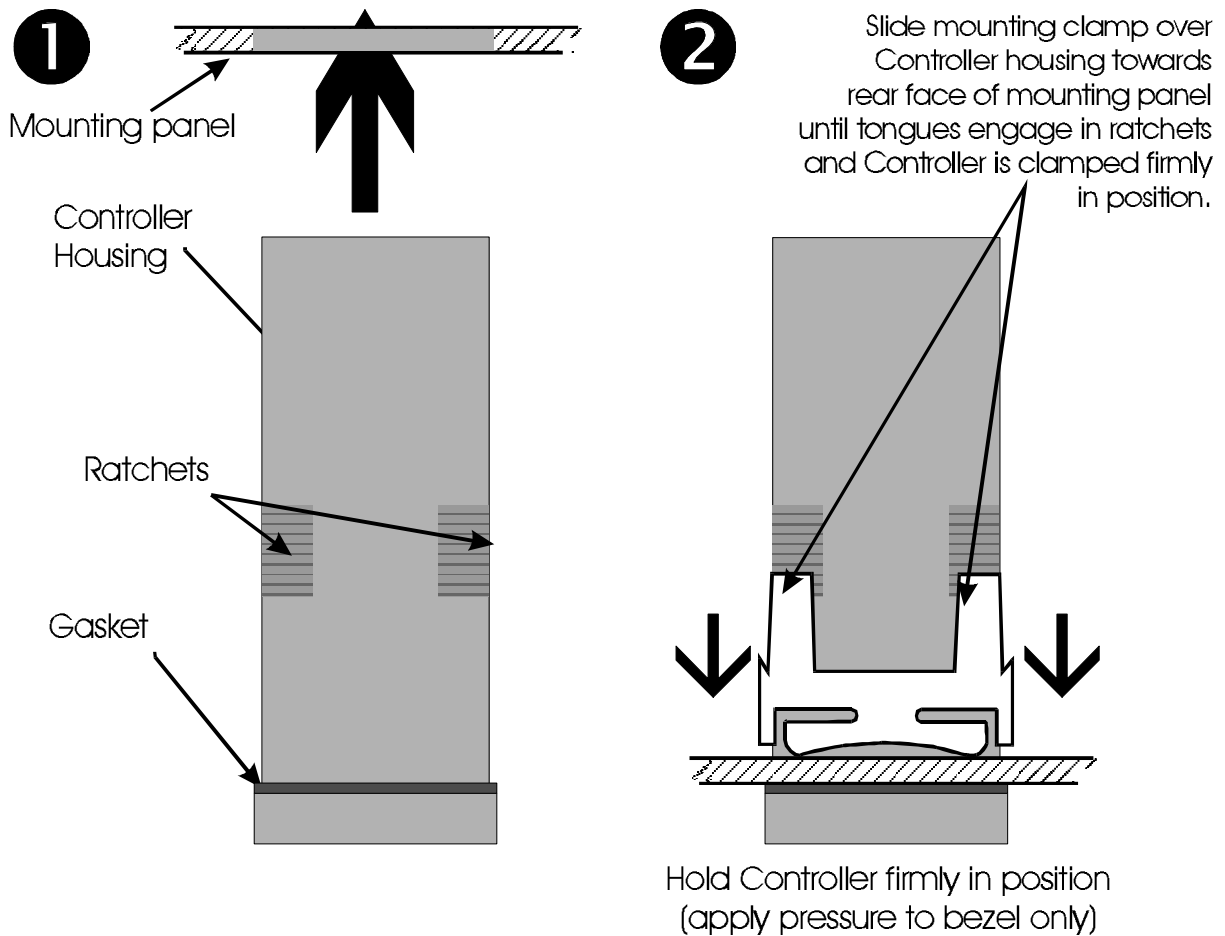

Figure 1-3 Panel-Mounting the Controller

1.3 CONNECTIONS AND WIRING

The rear terminal connections are illustrated in Figure 1-4 ($\frac{1}{16}$ -DIN Controllers) and Figure 1-5 ($\frac{1}{8}$ -DIN Controllers).

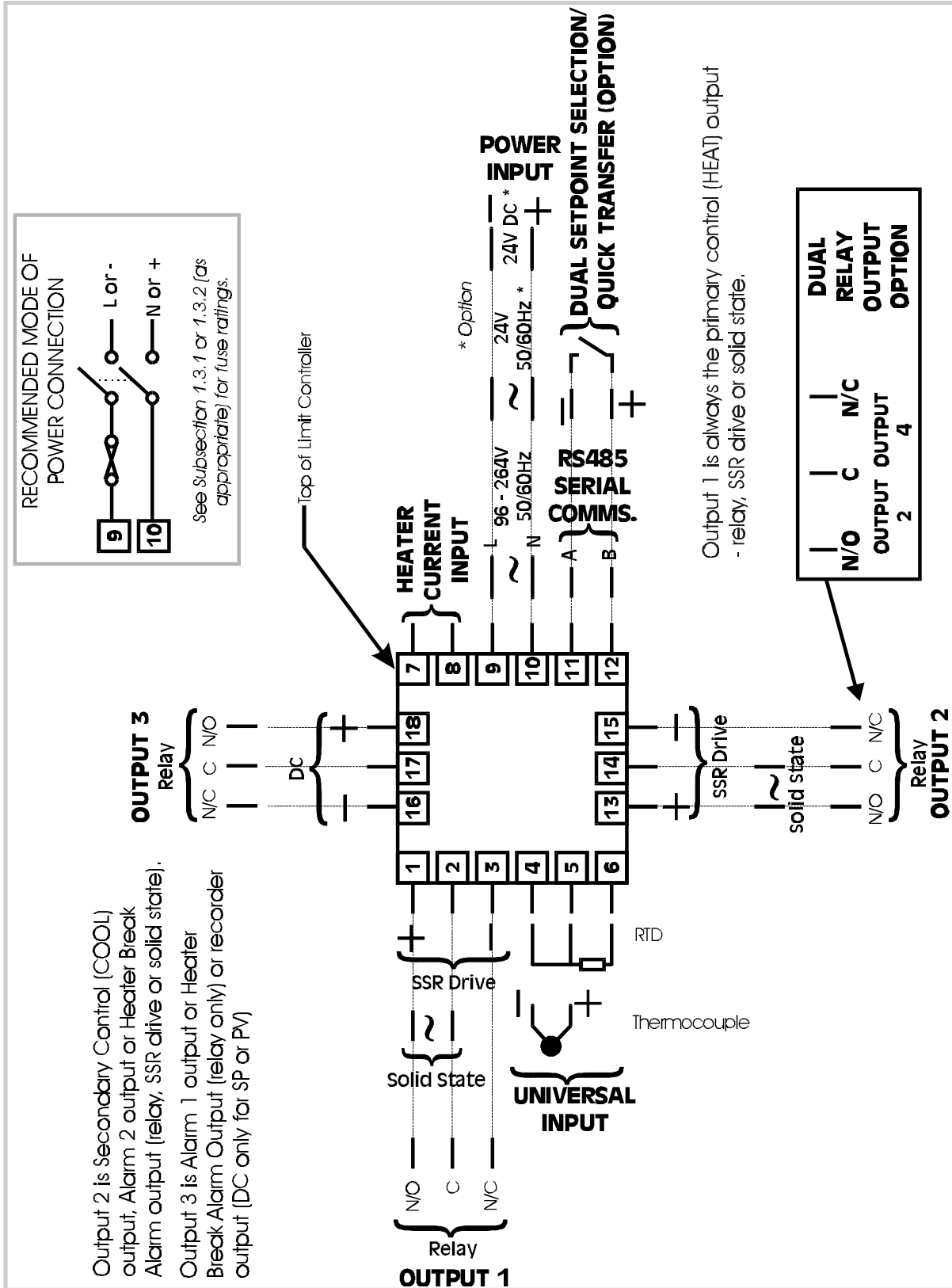

Figure 1-4 Rear Terminal Connections ($\frac{1}{16}$ -DIN Controllers)

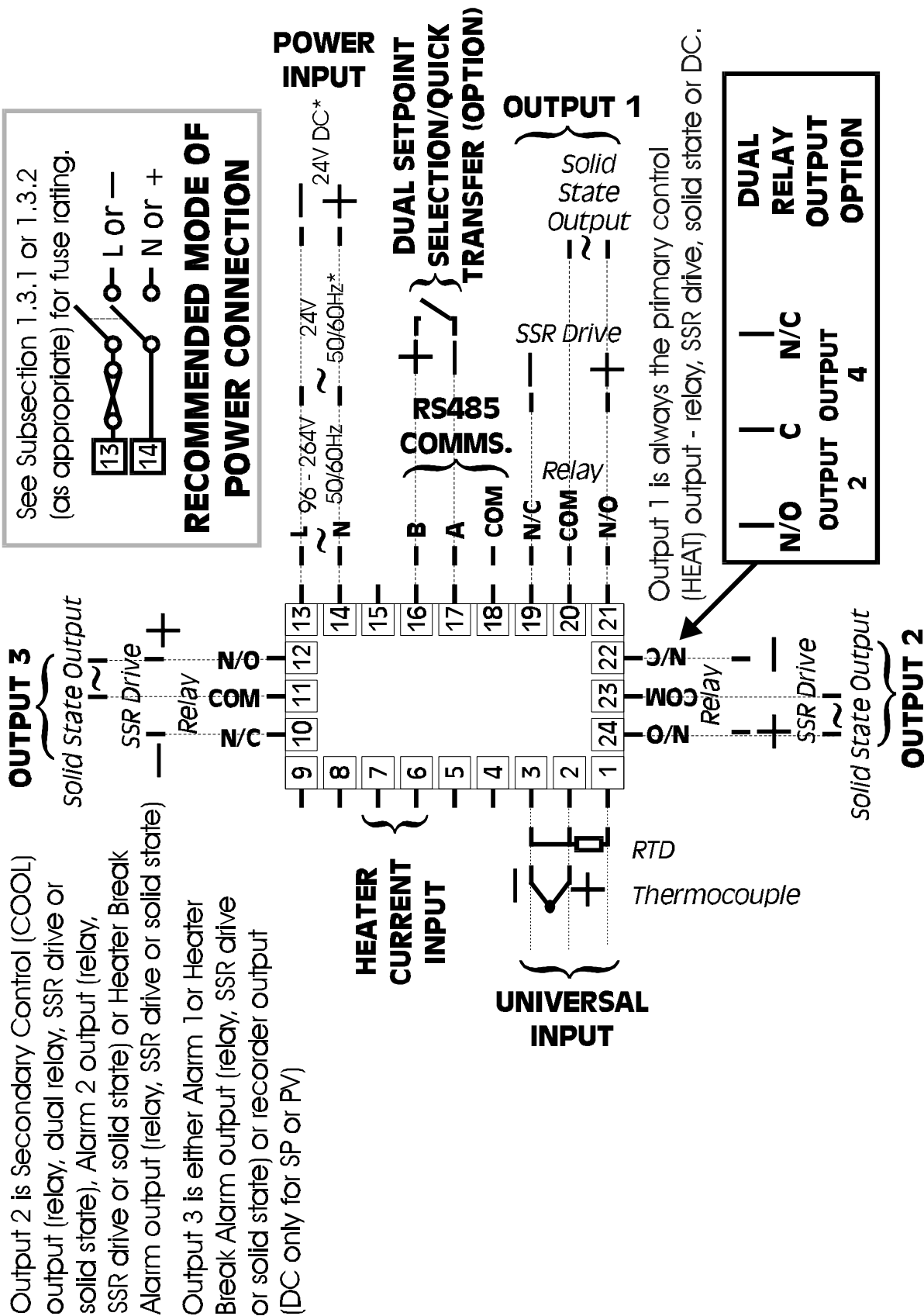

Figure 1-5 Rear Terminal Connections (1/8-DIN Controllers)

1.3.1 Mains (Line) Input

The Controller will operate on 96 - 264V AC 50/60Hz mains (line) supply. The power consumption is approximately 4 VA.

CAUTION: This equipment is designed for installation in an enclosure which provides adequate protection against electric shock. Local regulations regarding electrical installation should be rigidly observed. Consideration should be given to prevention of access to the power terminations by unauthorised personnel. Power should be connected via a two-pole isolating switch (preferably situated near the equipment) and a 1A fuse, as shown in Figures 1-4 and 1-5.

If the Controller has relay outputs in which the contacts are to carry mains (line) voltage, it is recommended that the relay contact mains (line) supply should be switched and fused in a similar manner but should be separate from the Controller mains (line) supply.

1.3.2 24V (Nominal) AC/DC Supply

The supply connections for the 24V AC/DC option of the Controller are as shown in Figures 1-4 and 1-5. Power should be connected via a two-pole isolating switch and a 315mA slow-blow (anti-surge Type T) fuse.

With the 24V AC/DC supply option fitted, these terminals will accept the following supply voltage ranges:

24V (nominal) AC 50/60Hz -	20 - 50V
24V (nominal) DC -	22 - 65V

1.3.3 Thermocouple Input

The correct type of thermocouple extension leadwire or compensating cable must be used for the entire distance between the Controller and the thermocouple, ensuring that the correct polarity is observed throughout. Joints in the cable should be avoided, if possible. The Controller's CJC facility must be enabled (normal conditions) for this input (see Subsection 3.3.13).

NOTE: Do not run thermocouple cables adjacent to power-carrying conductors. If the wiring is run in a conduit, use a separate conduit for the thermocouple wiring. If the thermocouple is grounded, this must be done at one point only. If the thermocouple extension lead is shielded, the shield must be grounded at one point only.

1.3.4 RTD Inputs

The compensating lead should be connected to Terminal 4 ($\frac{1}{16}$ -DIN Controllers) or Terminal 3 ($\frac{1}{8}$ -DIN Controllers). For two-wire RTD inputs, Terminals 4 and 5 ($\frac{1}{16}$ -DIN Controllers) or terminals 2 and 3 ($\frac{1}{8}$ -DIN Controllers) should be linked. The extension leads should be of copper and the resistance of the wires connecting the resistance element should not exceed 5 ohms per lead (the leads should be of equal length).

1.3.5 Dual Setpoint Selection Input

With the Dual Setpoint/Quick Transfer option fitted and Hardware Option parameter set to **duAL** (see Subsection 3.2), Terminals 11 and 12 ($\frac{1}{16}$ -DIN Controllers) or Terminals 16 and 17 ($\frac{1}{8}$ -DIN Controllers) are used for external selection of the active setpoint. These terminals may be connected to (a) the voltage-free contacts of a switch or relay, or (b) a TTL-compatible voltage. Setpoint selection is as follows:

Voltage-Free:	Contacts open - Setpoint 1 selected Contacts closed - Setpoint 2 selected
TTL-compatible:	>2.0V - Setpoint 1 selected <0.8V - Setpoint 2 selected

NOTE: The Dual Setpoint/Quick Transfer option and the RS485 Serial Communications option are mutually exclusive.

1.3.6 Remote Heater Current Transfer Input (Quick Transfer)

With the Dual Setpoint/Quick Transfer option fitted and hardware Option parameter set to **trAn** (see Subsection 3.2.2), Terminals 11 and 12 ($\frac{1}{16}$ -DIN Controllers) or Terminals 16 and 17 ($\frac{1}{8}$ -DIN Controllers) are used to instigate externally transfer of the currently-displayed heater current value to the Heater Nominal Current parameter (see Volume 1, Subsection 3.2.30). These terminals may be connected to (a) the voltage-free contacts of a switch or relay, or (b) a TTL-compatible voltage. The transfer will occur when this input detects an "Open - Closed" transition in the switch/relay contacts or a rising edge in the TTL level. TTL-compatible level voltages are as for the Dual Setpoint Selection input (see above).

NOTE: The Dual Setpoint/Quick Transfer option and the RS485 Serial Communications option are mutually exclusive.

1.3.7 Heater Current Input

Terminals 7 and 8 ($\frac{1}{16}$ -DIN Controllers) or Terminals 6 and 7 ($\frac{1}{8}$ -DIN Controllers) are for connection to the secondary winding of an external current transformer, the

primary winding of which carries the heater current. The current carried by the primary winding and the transformer ratio are then taken into account when setting the Heater Current parameters (see Volume 1, Section 3).

1.3.8 Relay Outputs

The contacts are rated at 2A resistive at 120/240V AC.

1.3.9 SSR Drive Outputs

These outputs produce a time-proportioned non-isolated DC signal:

Output 1:	>10V DC into 500 Ω minimum
Output 2:	>4.5V DC into 250 Ω minimum

1.3.10 Solid State Outputs

These outputs provide up to 1A AC drive with a longer lifetime than an electromechanical relay. For further details, refer to Appendix A.

1.3.11 DC Outputs

Only Output 3 may be a DC output (Recorder Output only). See Appendix A.

1.3.12 RS485 Serial Communications Link

The cable used should be suitable for data transfer at the selected rate (1200, 2400, 4800 or 9600 Baud) over the required distance. Transmitters/receivers conform to the recommendations in the EIA Standard RS485.

The "A" terminal on the Controller should be connected to the "A" terminal on the master device; the "B" terminal on the Controller should be connected to the "B" terminal on the master device. Where several Controllers are connected to one master port, the master port transceiver in the active state should be capable of driving a load of 12k Ω per Controller; the master port transceiver in the passive state must have pull-up/pull-down resistors of sufficiently low impedance to ensure that it remains in the quiescent state whilst supplying up to $\pm 100\mu\text{A}$ each to the Controller transceivers in the high impedance state.

NOTES:

1. The RS485 Serial Communications option and the Dual Setpoint/Quick Transfer option are mutually exclusive.
2. The Controller receiver presents $\frac{1}{4}$ standard RS485 unit load. *The total receiver load on the communications system must not exceed 32 standard RS485 unit loads.*

2 INTERNAL LINKS AND SWITCHES

2.1 REMOVING THE CONTROLLER FROM ITS HOUSING

CAUTION: Before removing the Controller from its housing, ensure that all power has been removed from the rear terminals.

To withdraw the Controller from its housing, simply grip the side edges of the front panel (there is a finger grip on each edge) and pull the Controller forwards. This will release the Controller from its rear connectors in the housing and will give access to the Controller PCBs. Take note of the orientation of the Controller for subsequent replacement into the housing. The positions of the PCBs in the Controller are shown in Figure 2-1.

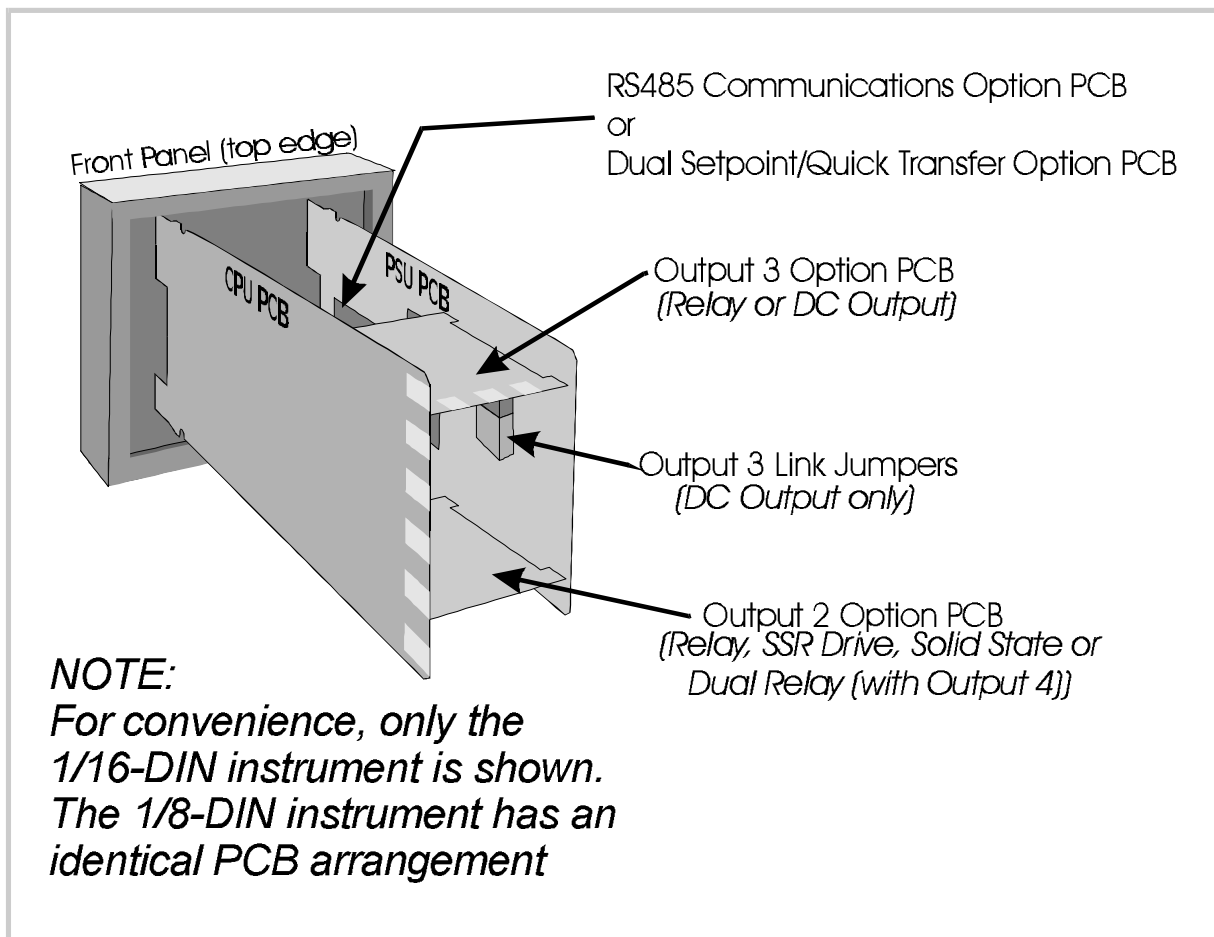

Figure 2-1 PCB Positions

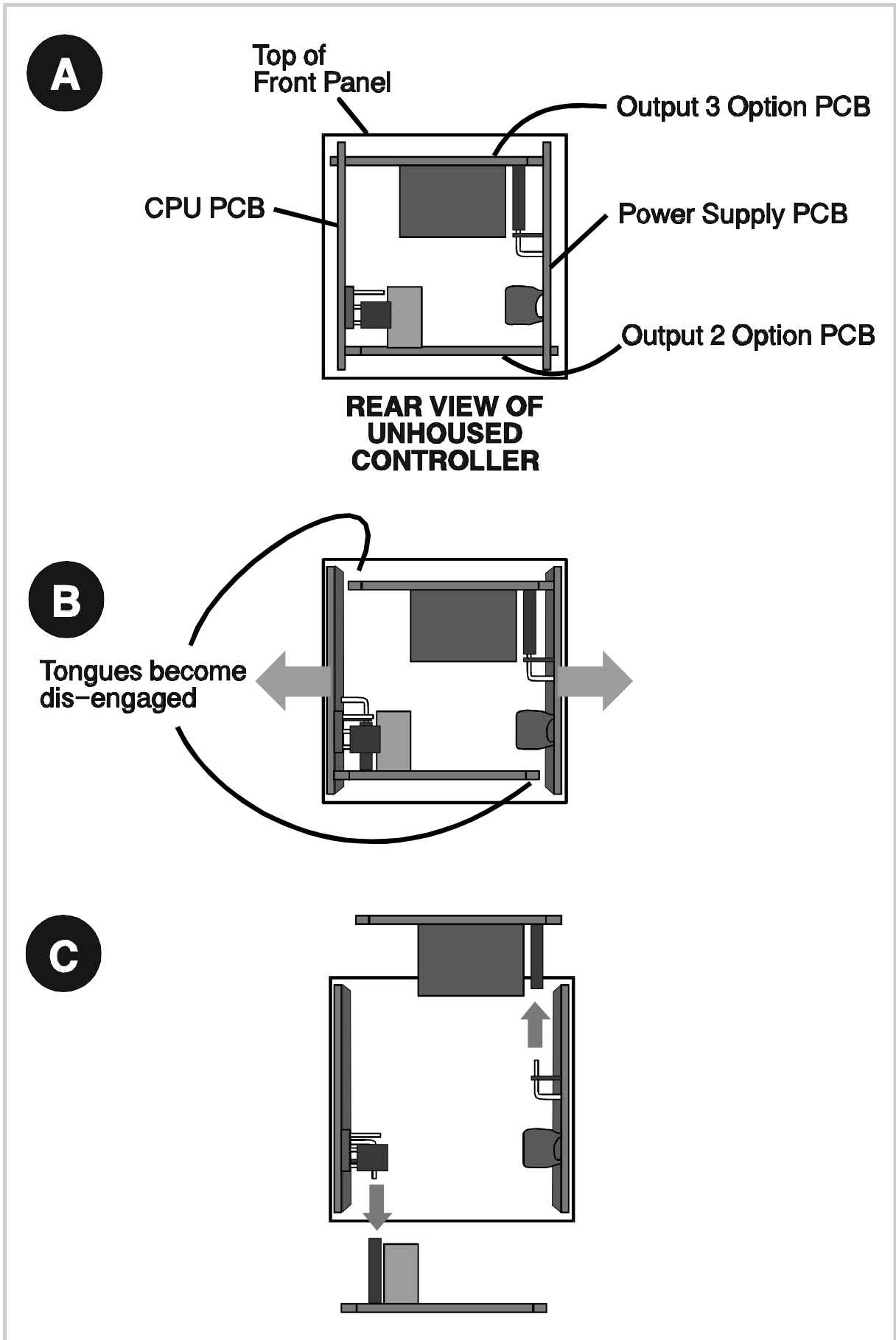

Figure 2-2 Removing the Output 2/Output 3 Option PCBs

2.2 REMOVING/REPLACING THE OUTPUT 2/OUTPUT 3 OPTION PCBs

With the Controller removed from its housing:

1. Gently push the rear ends of the CPU PCB and Power Supply PCB apart slightly, until the two tongues on each of the Output 2/Output 3 Option PCBs become dis-engaged - see Figure 2-2B; The Output 2 Option PCB tongues engage in holes in the Power Supply PCB and the Output 3 Option PCB tongues engage in holes on the CPU PCB.

2. Carefully pull the required Option PCB (Output 2 or Output 3) from its connector (Output 2 Option PCB is connected to the CPU PCB and Output 3 Option PCB is connected to the Power Supply PCB) - see Figure 2-2C. Note the orientation of the PCB in preparation for its replacement.

Adjustments may now be made to the link jumpers on the CPU PCB, the PSU PCB and (if fitted) the DC Output 3 Option PCB. The replacement procedure is a simple reversal of the removal procedure.

2.3 REMOVING/REPLACING THE RS485 OPTION PCB OR DUAL SETPOINT/REMOTE HEATER CURRENT TRANSFER OPTION PCB

The RS485 Communications Option PCB or Dual Setpoint/Remote Heater Current Transfer Option PCB is mounted on the inner surface of the PSU PCB and can be removed when the Controller is removed from its housing (see Subsection 2.1) Figure 2-3 illustrates the removal/replacement procedure. *It is not necessary to remove the Output 2/Output 3 Option PCBs to perform this procedure.*

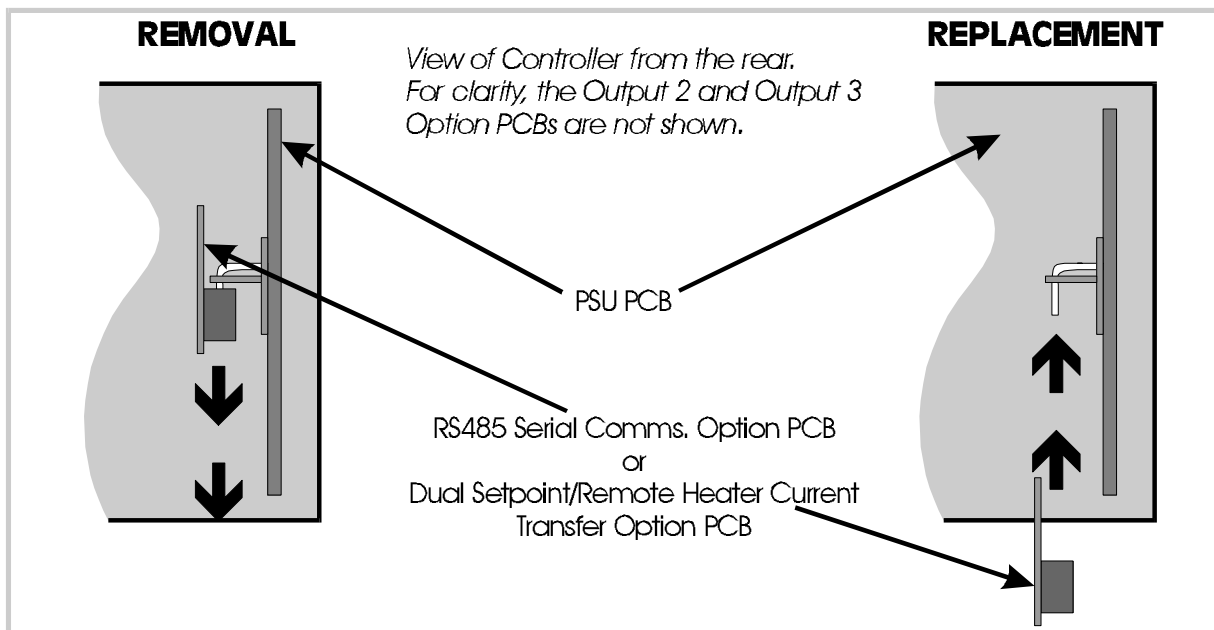

Figure 2-3 Removing/Replacing the RS485 Communications Option PCB or Dual Setpoint/Remote Heater Current Transfer Option PCB

2.4 REPLACING THE CONTROLLER IN ITS HOUSING

To replace the Controller, simply align the CPU PCB and Power Supply PCB with their guides and connectors in the housing and slowly but firmly push the Controller into position.

CAUTION: Ensure that the instrument is correctly orientated. A stop will operate if an attempt is made to insert the instrument in the wrong orientation (e.g. upside-down). *This stop must not be over-ridden.*

2.5 SELECTION OF OUTPUT 1 TYPE

The Output 1 type is selected by Link Jumpers LJ4, LJ5, LJ6 and LJ7 on the CPU PCB ($\frac{1}{16}$ -DIN Controllers - see Figure 2-4) or the PSU PCB ($\frac{1}{8}$ -DIN Controllers - see Figure 2-5).

Output 1 Type	Link Jumpers Fitted
Relay or Solid State	LJ5 & LJ6
SSR Drive	LJ4 & LJ7

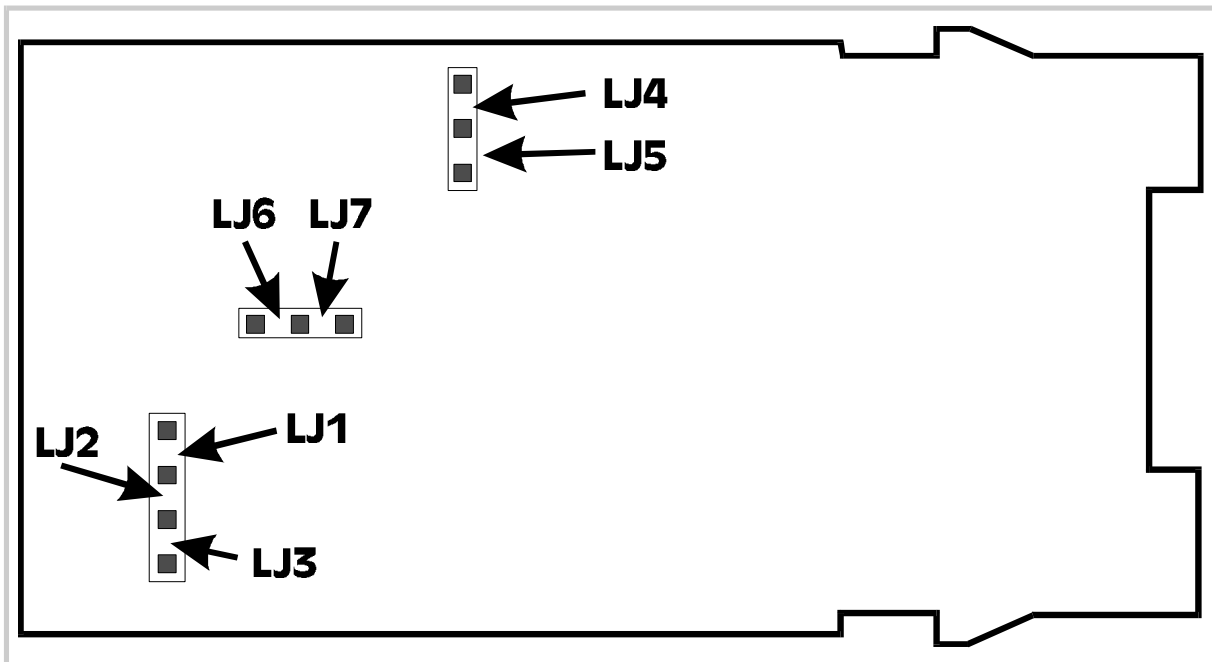

Figure 2-4 CPU PCB Link Jumpers - $\frac{1}{16}$ -DIN Controllers

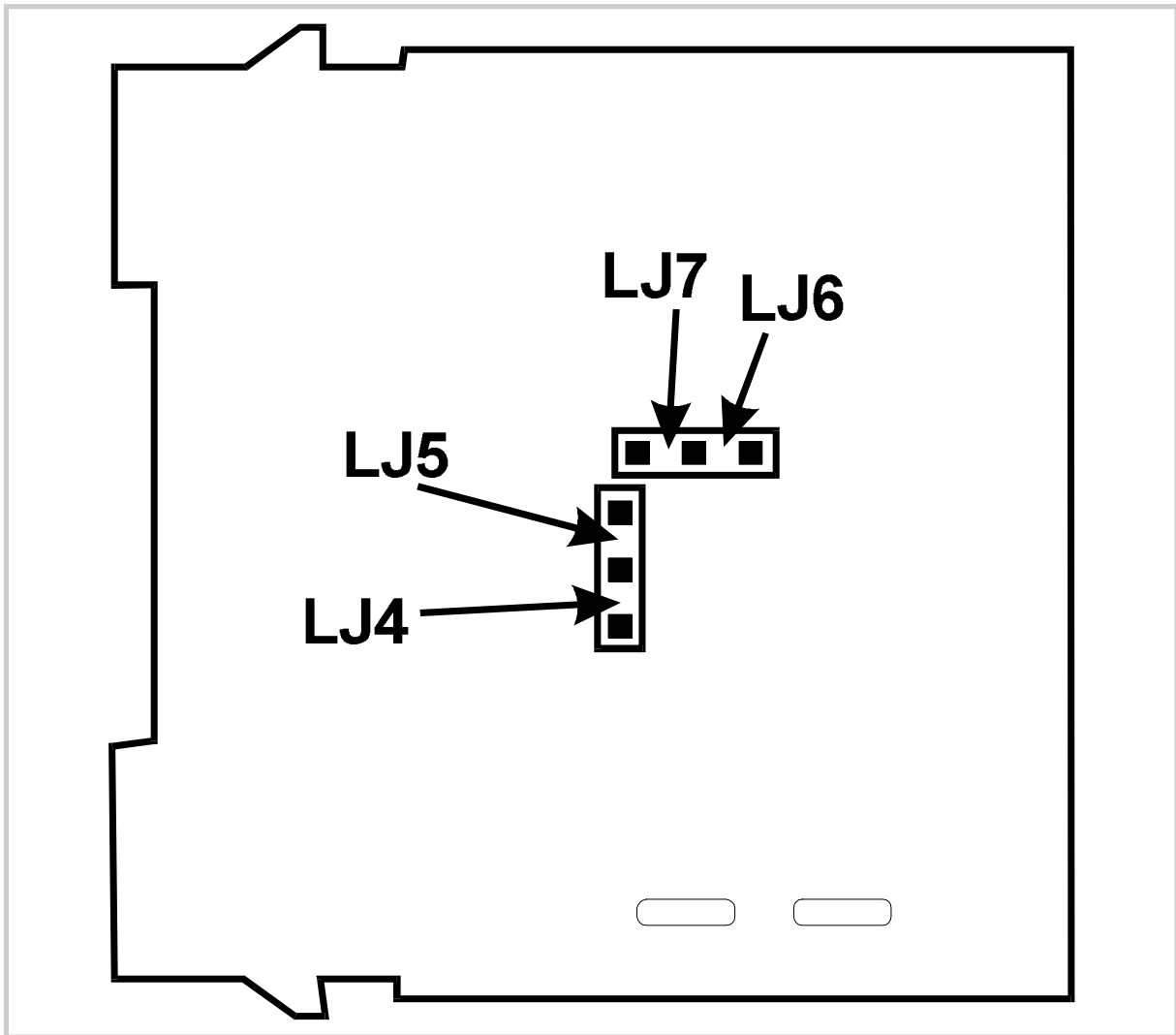

Figure 2-5 PSU PCB Link Jumpers - $\frac{1}{8}$ -DIN Controllers

2.6 OUTPUT 2 TYPE/OUTPUT 3 TYPE

The type of output for Output 2 and Output 3 is determined by the Option PCB fitted in the appropriate position (see Figure 2-1) and, in the case of the DC Output 3 Option PCB being fitted, the setting of Link Jumpers LJ8 and LJ9 on that Option PCB (see Figure 2-5 and table). There are five types of option PCB which may be used:

1. Relay Output Option PCB (Output 2 or Output 3) - no link jumpers
2. Solid State Output Option PCB (Output 2 or Output 3) - no link jumpers
3. Dual Relay Output 2 Option PCB - (with Output 4) - no link jumpers
4. SSR Drive Output 2 Option PCB - no link jumpers
5. DC Output 3 Option PCB (link jumpers as shown in Figure 2-5)

WARNING: Do not attempt to fit the Dual Relay Option PCB into the Output 3 (upper) Option PCB position.

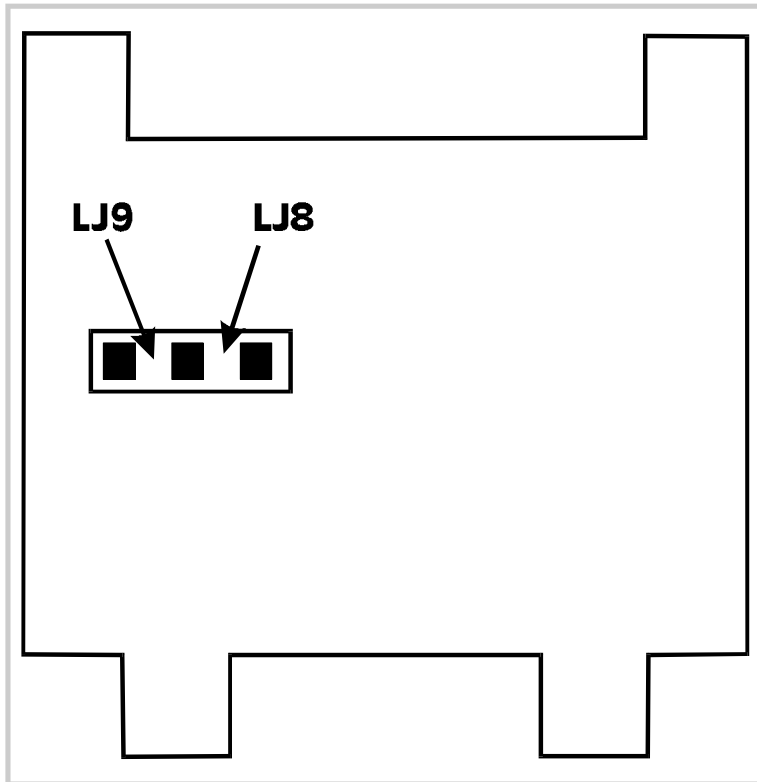

DC Output 3 Range	Link Jumpers Fitted
DC (0 - 10V)	LJ8
DC (0 - 20mA)	LJ9
DC (0 - 5V)	LJ8
DC (4 - 20mA)	LJ9

Figure 2-6 DC Output 3 Option PCB
- Link Jumpers

3 CONFIGURATION MODE

3.1 ENTRY INTO CONFIGURATION MODE

To enter Configuration Mode:

1 Power-up the Controller.

 Within 30 secs. as 1st key action after power-up.

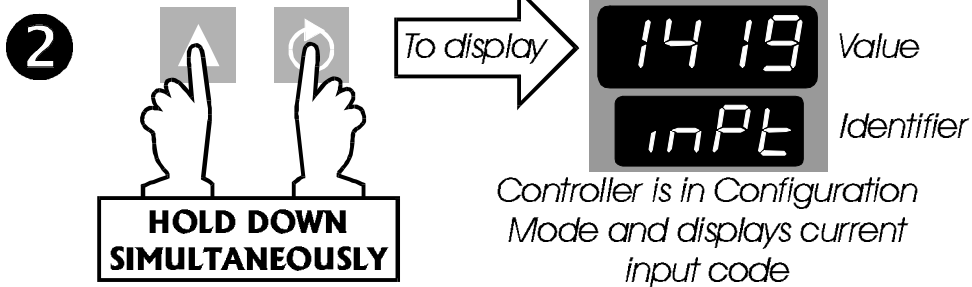

In Configuration Mode:

To select parameter



To change value (upper display flashes)

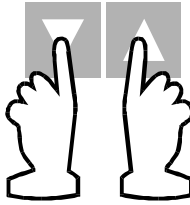

To confirm new value (upper display is static)



NOTE: Changes to the setting of certain Configuration Mode parameters (e.g. input range, output use and type) will cause the Set Up Mode parameters to be automatically set to their default values the next time Set Up Mode is entered (see also Volume 1, beginning of Section 3).

3.2 HARDWARE DEFINITION CODE, OPTION SELECTION AND HEATER BREAK INPUT TYPE

These are special facilities in Configuration Mode, used as follows:

- Hardware Definition Code: Represents the hardware fitted (input type, Output 1 type, Output 2 type and Output 3 type); must be compatible with the hardware actually fitted.
- Option Selection: Defines hardware option fitted.
- Heater Break Input Type: Defines the type of input used for heater break sensing.

These facilities are accessed as follows:

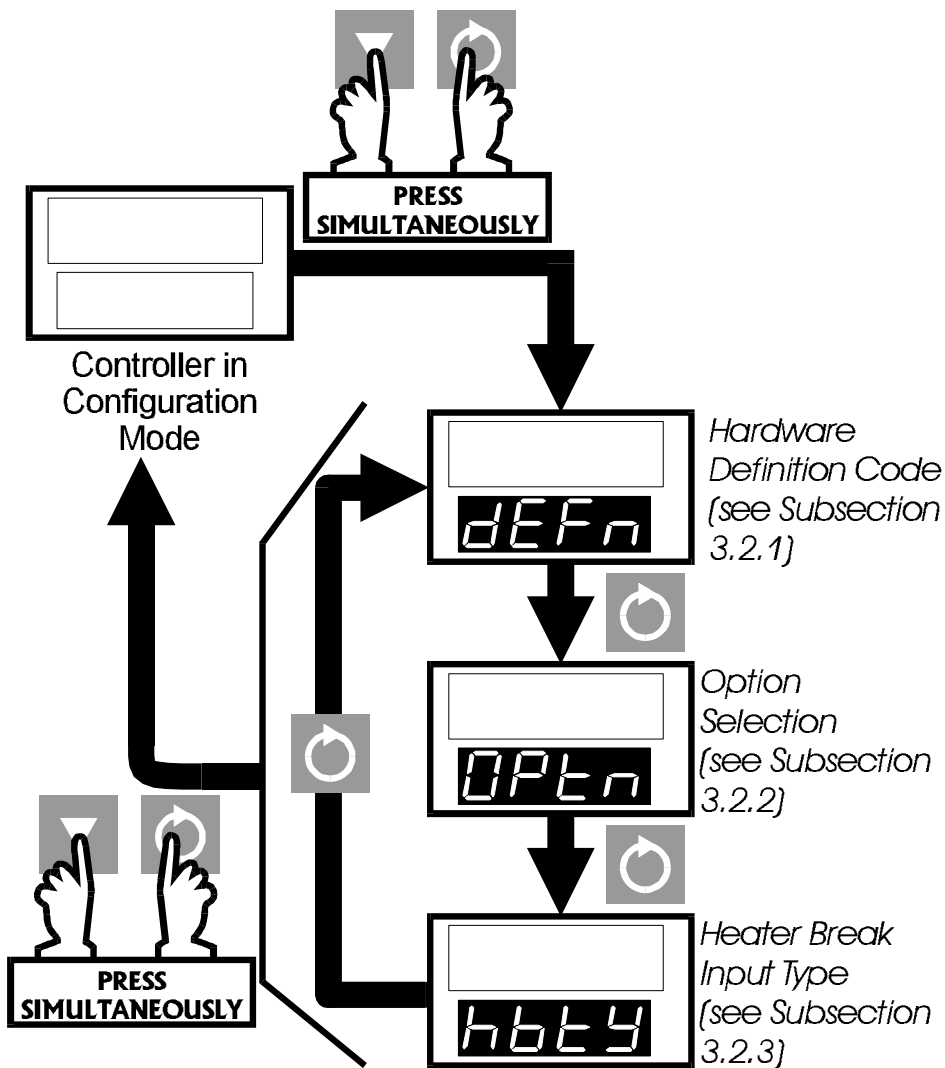

3.2.1 Hardware Definition Code

The Hardware Definition Code is displayed in the following format:

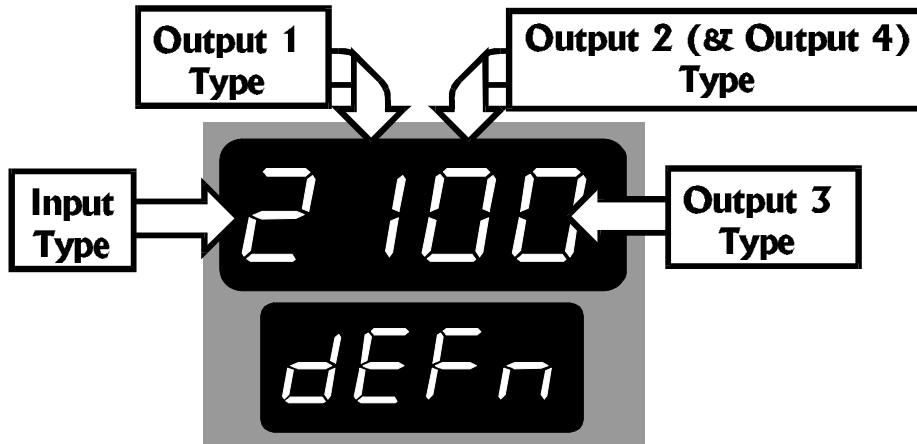

Table 3-1 Hardware Definition Code - Input/Output Selection

Value	0	1	2	3	4	5	7	8	9
Input		RTD Input	Thermo-couple Input						
Output 1		Relay Output	SSR Drive Output					Solid State Output	
Output 2 (& 4)	Not fitted	Relay Output 2	SSR Drive Output 2					Solid State Output 2	Relay Output 2 & 4 *
Output 3	Not fitted	Relay Output		DC 0-10V Output	DC 0-20mA Output	DC 0-5V Output	DC 4-20mA Output	Solid State Output	

* Dual Relay Option PCB must be fitted

- NOTES:
1. If Output 2 is set to be a relay/SSR Drive/Solid State output, it may be a control output (COOL) or an alarm output; if it is set to be a Dual Relay output, it includes Output 4 (Heater Break Alarm output)
 2. If Output 3 is set to be a relay or solid state output, it can only be an alarm output; if it is set to be a DC output, it can only be a recorder output (i.e. re-transmitted process variable or setpoint output).

The displayed code may be adjusted (and new values confirmed) as described on the previous page. The maximum setting available for this code is 2898. For

example, the code for a thermocouple input, relay primary output (Output 1) and relay Output 3 would be 2101.

NOTE: It is essential that this code is changed promptly whenever there is a change to the Controller's hardware configuration (change of input/output type, alarm/recorder output added/removed etc.). The Controller software depends upon this code to ensure that the Controller operates correctly.

This code may be viewed as a Read Only display in Operator Mode (see Volume 1, Subsection 2.16).

3.2.2 Option Selection

This indicates the option fitted (if any). Using the Raise/Lower keys, the display may be set to one of:

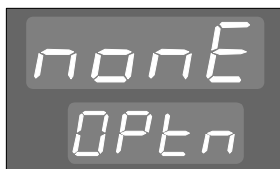

No option fitted



Dual Setpoint Option fitted. Terminals 11 and 12 used to select Setpoint 1 or Setpoint 2 (see Subsection 1.3.5).

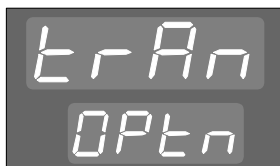

Heater Current Quick Transfer Option fitted. Terminals 11 and 12 used to instigate transfer of the current Heater Current value to the Heater Nominal Current parameter (see Subsection 1.3.6).



Standard RS485 Communications; maximum address range 1 - 128 (MODBUS) or 1 - 99 (ASCII).



Enhanced RS485 Communications; maximum address range 1 - 255 (MODBUS) or 1 - 99 (ASCII).

The displayed option selection may be adjusted (and new values confirmed) as described previously.

3.2.3 Heater Break Input Type

The following input types are available:



Standard Heater Break Alarm using an external current transformer (Terminals 7 and 8). This permits the use of the Low Heater Break Alarm, High Heater Break Alarm and Short Circuit Heater Break Alarm.



Two-wire connection to special thyristor unit (SCRs) via Terminals 7 and 8. This permits the use of the Low Heater Break Alarm and the High Heater Break Alarm *but not the Short Circuit Heater Break Alarm.*

Selection/confirmation is achieved with the Raise/Lower and **AM** keys, as previously described.

3.3 CONFIGURATION MODE PARAMETERS

3.3.1 Input Range

When Configuration Mode is first entered, this parameter will be displayed in the form:



The default setting is dependent upon the input hardware fitted, as indicated by the first (left-most) digit of the Hardware Definition Code (see Subsection 3.2.1):

Input Hardware Fitted	Default Setting
Thermocouple	1419 (Type "J", 0 to 760°C)
RTD (Pt100)	7220 (RTD Pt100, 0 to 800°C)

If the Hardware Definition Code is at its default setting, input code 1419 will be displayed. The input ranges and codes available are listed in Appendix A.

3.3.2 Output 1 Action

When this item is selected, the displays will be either of:

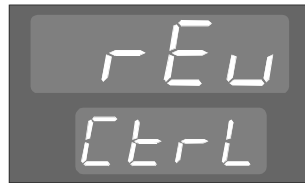

Output 1 reverse-acting



Output 1 direct-acting

The setting can be changed and confirmed as previously described. The default setting is reverse-acting.

NOTE: If the secondary output is chosen as Output 2 (COOL) control output, its action is always the complement of the action of Output 1.

3.3.3 Alarm 1 Type

When this item is selected, the displays will be of the form:



the upper display indicating the current Alarm 1 type, which may be one of:

P_h i Process High Alarm

bAnd Band Alarm

P_Lo Process Low Alarm

nOnE No alarm

dE Deviation Alarm

The setting can be changed and confirmed as previously described. The default setting is Process High alarm. The operation of the alarm types is shown in Volume 1, Figure 3-2.

3.3.4 Alarm 2 Type

When this item is selected, the displays will be of the form:



the upper display indicating the current Alarm 2 type. The alarm types available are as for Alarm 1 (see Subsection 3.3.3). The setting can be changed and confirmed as previously described. The default setting is Process Low alarm. The operation of the alarm types is shown in Volume 1, Figure 3-2.

3.3.5 Alarm Inhibit

When this item is selected, the displays will be of the form:



where the upper display can be one of:



No alarms
inhibited



Alarm 1
inhibited



Alarm 2
inhibited



Both alarms
inhibited

On power-up, an “alarm” condition may occur, based on the alarm value, the process variable value and, if appropriate to the alarm type, the (active) setpoint value. This would normally activate an alarm; however, if the pertinent alarm is inhibited, the alarm indication is suppressed and the alarm will remain inactive. This will prevail until the “alarm” condition returns to the “inactive” state, whereafter the alarm will operate normally.

Also, during dual setpoint operation, whenever there is switching from Setpoint 1 to Setpoint 2 (or vice versa), similar alarm suppression will occur, if the pertinent alarm is inhibited.

NOTE: The Alarm Inhibit function is not applied to any of the Heater Break Alarms.

3.3.6 Heater Break Alarm Strategy

This defines the terms in which the heater break alarm level is expressed:

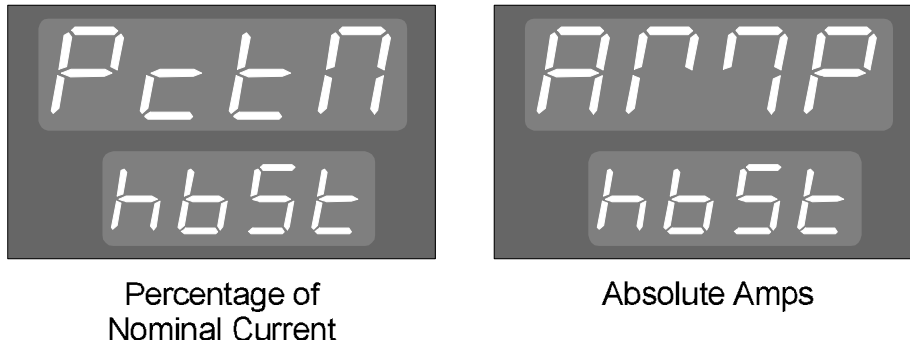

Selection/confirmation is as previously described.

NOTE: When this parameter is set to the Absolute Amps mode, the Heater Nominal Current parameter (Set Up Mode - see Volume 1 Section 3) is not available and Quick Transfer (see Volume 1 Subsection 2.13) is disabled.

3.3.7 Output 2 Usage

The displays for this item are of the form:



in which the upper display indicates the usage, which will be one of the following:

	Output 2 control (COOL) output		Direct-acting Logical OR of Alarm 1 with Alarm 2
	Alarm 2 output, direct-acting		Reverse-acting Logical OR of Alarm 1 with Alarm 2
	Alarm 2 output, reverse-acting		Direct-acting Logical AND of Alarm 1 with Alarm 2
	Heater Break Alarm output, direct-acting		Reverse-acting Logical AND of Alarm 1 with Alarm 2
	Heater Break Alarm output, reverse-acting		











This setting can be changed and confirmed in the manner previously described. The default setting is Alarm 2 hardware output, direct-acting. The operation of the different alarm types is illustrated in Volume 1, Figure 3-2. The operation of logically-combined (AND/OR) alarms is explained in the table above.

3.3.8 Output 3 Usage

The displays for this item are of the form:



in which the upper display indicates the usage, which will be one of the following:

	Alarm 1 output, direct-acting (Relay,SSR Drive or Solid State only)		Reverse-acting; logical AND of Alarms 1 & 2 (Relay,SSR Drive or Solid State only)
	Alarm 1 output, reverse-acting (Relay,SSR Drive or Solid State only)		Heater Break Alarm, direct-acting (Relay, SSR Drive or Solid State only)
	Direct-acting; logical OR of Alarms 1 & 2 (Relay,SSR Drive or Solid State only)		Heater Break Alarm, reverse-acting (Relay, SSR Drive or Solid State only)
	Reverse-acting; logical OR of Alarms 1 & 2 (Relay,SSR Drive or Solid State only)		Recorder Output - Setpoint (DC only)
	Direct-acting; logical AND of Alarms 1 & 2 (Relay,SSR Drive or Solid State only)		Recorder Output - Process Variable (DC only)



This setting can be changed and confirmed in the manner previously described. The default setting is Alarm 1, direct-acting (for a relay/SSR output) or Process Variable Recorder Output (for a DC output). The operation of the different alarm types is illustrated in Volume 1, Figure 3-2. The operation of logically-combined (AND/OR) alarms is explained in the table above.

3.3.9 Output 4 Usage

The displays for this item are of the form:



in which the upper display indicates the usage, which will be one of the following:

-  Heater Break Alarm, direct-acting
(Relay, SSR Drive or Solid State output only)
-  Heater Break Alarm, reverse-acting
(Relay, SSR Drive or Solid State output only)

3.3.10 Communications Link Baud Rate

When this item is selected, the initial display is of the form:



The Baud rate may be selected and confirmed as described earlier in this Section. The Baud rates available are 1200, 2400, 4800 and 9600

3.3.11 Communications Protocol

This determines the protocol used over the communications link. Four options are available:

- | | | | |
|---|---|--|---|
|  |  |  |  |
| MODBUS RTU
no parity | MODBUS RTU
odd parity | MODBUS RTU
even parity | ASCII |

Selection/confirmation is as previously described.

3.3.12 Communications Address

The unique communications address assigned to the Controller can be selected using this item, for which the displays are of the form:



The address can be selected and confirmed in the manner previously described. Any value in the following ranges can be used, subject to the total receiver loading restrictions detailed in NOTE 2 in Subsection 1.3.12:

- MODBUS RTU protocol: 1 - 128 (standard RS485 option)
 1 - 255 (enhanced RS485 option)
- ASCII protocol: 1 - 99 (standard and enhanced RS485 options)

3.3.13 Cold Junction Compensation Enable/Disable

The display for this item is either of:

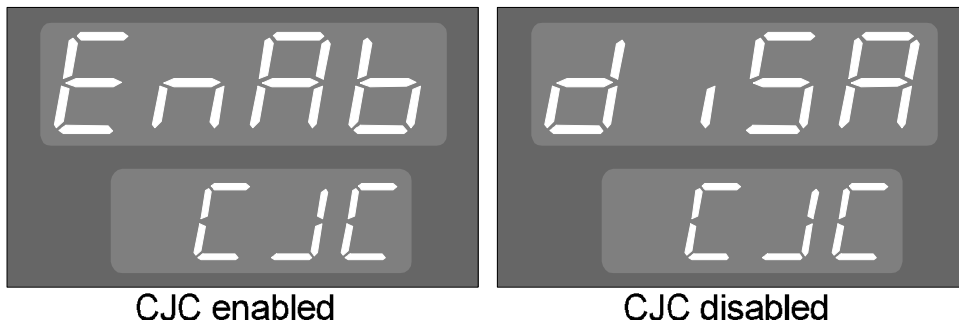

This setting can be changed and confirmed in the manner previously described. The default setting is Enabled. This parameter is omitted from the Configuration Mode display sequence if the input type selected is not thermocouple (see Subsection 3.2.1). If the CJC facility is disabled, the initial display in Operator Mode will show:

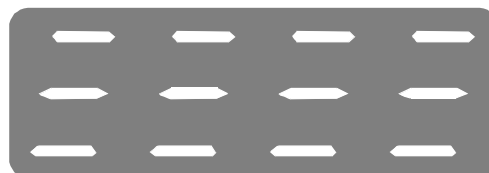

flashing in the lower display.

3.3.14 Lock Code

When this item is selected, the displays will be of the form:



where the upper display shows the current Set Up Mode Lock Code (a Read Only display - it cannot be edited in Configuration Mode). This serves as a reminder in case the Lock Code has been forgotten (see also Volume 1, Subsection 3.2.41).

3.4 EXIT FROM CONFIGURATION MODE

To leave Configuration Mode,, depress the Raise and Function keys simultaneously. This will cause a return to the Operator Mode to be made.

NOTE: An automatic exit to Operator Mode will be made if, in Configuration Mode, there is no front panel key activity for two minutes.

The exit is made via the power-up self-test routines which include a lamp test.

A PRODUCT SPECIFICATION

A.1 UNIVERSAL INPUT

General

Maximum per Controller:	One
Input Sample Rate:	Four samples/second
Digital Input Filter:	Time constant selectable from front panel - 0.0 (i.e. OFF), 0.5 to 100.0 seconds in 0.5-second increments.
Input Resolution:	14 bits approximately; always at least four times better than display resolution.
Input Impedance:	Greater than 100MΩ resistive.
Isolation:	Universal input isolated from all outputs except SSR at 240V AC.
Process Variable Offset:	Adjustable ±input span.

Thermocouple: Ranges selectable from front panel:

Type	Input Range	Displayed Code	Type	Input Range	Displayed Code
R	0 - 1650°C	1127	J	32 - 1401°F †	1420
R	32 - 3002°F	1128	T	-200 - 262°C	1525
S	0 - 1649°C	1227	T	-328 - 503°F	1526
S	32 - 3000°F	1228	T	0.0 - 260.6°C	1541
J	0.0 - 205.4°C	1415	T	32.0 - 501.0°F	1542
J	32.0 - 401.7°F	1416	K	-200 - 760°C	6726
J	0 - 450°C	1417	K	-328 - 1399°F	6727
J	32 - 842°F	1418	K	-200 - 1373°C	6709
J	0 - 761°C *	1419	K	-328 - 2503°F	6710

* Default (not North America)
 † Default (North America)

Continued overleaf.....

Type	Input Range	Displayed Code	Type	Input Range	Displayed Code
L	0.0 - 205.7°C	1815	L	32 - 1403°F	1820
L	32.0 - 402.2°F	1816	B	211 - 3315°F	1934
L	0 - 450°C	1817	B	100 - 1824°C	1938
L	32 - 841°F	1818	N	0 - 1399°C	5371
L	0 - 762°C	1819	N	32 - 2550°F	5324

Calibration: Complies with BS4937, NBS125 and IEC584.

Sensor Break Protection: Break detected within two seconds.

Resistance Temperature Detector (RTD): Ranges selectable from front panel:

Input Range	Displayed Code	Input Range	Displayed Code
0 - 800°C *	7220	0.0 - 100.9°C	2295
32 - 1471°F †	7221	32.0 - 213.6°F	2296
32 - 571°F	2229	-200 - 206°C	2297
-100.9 - 100.0°C	2230	-328 - 402°F	2298
-149.7 - 211.9°F	2231	-100.9 - 537.3°C	7222
0 - 300°C	2251	-149.7 - 999.1°F	7223

* Default (not North America)

† Default (North America)

Type and Connection: Three-wire Pt100

Calibration: Complies with BS1904 and DIN43760.

Lead Compensation: Automatic scheme.

RTD Sensor Current: 150µA (approximately)

Sensor Break Protection: Break detected within two seconds.

A.2 DUAL SETPOINT/QUICK TRANSFER SELECTION INPUT (OPTION)

Type:	Voltage-free or TTL-compatible
Voltage-Free Operation:	Connection to contacts of external switch/relay; contacts open = Setpoint 1 selected (min. contact resistance = 5000Ω), contacts closed = Setpoint 2 selected (max. contact resistance = 50Ω).
TTL levels:	To select Setpoint 1: $-0.6V$ to $0.8V$ To select Setpoint 2: $2.0V$ to $24.0V$
Maximum Input Delay (OFF-ON):	1 second
Minimum Input Delay (ON-OFF):	1 second

A.3 HEATER CURRENT INPUT

Input Sampling Method:	Delta-Sigma at 1kHz.
Input Resolution:	8 bits over 250ms rolling window 10 bits over 1s rolling window
Isolation:	Via external current transformer.
Internal Burden	15Ω
Primary Input Range Maximum:	Adjustable 10.0A - 20.0A rms in 0.1A increments, 21A - 100A rms in 1A increments.
Primary Input Range Minimum:	Fixed at 0A.
Secondary Input Span:	0 - 50mA rms (assuming sinusoidal input current waveform).

A.4 OUTPUT 1

General

Types Available: Relay, SSR Drive/TTL and Solid State.

Relay

Contact Type: Single pole double throw (SPDT).

Rating: 2A resistive at 120/240V AC.

Lifetime: >500,000 operations at rated voltage/current.

Isolation: Inherent.

SSR Drive/TTL

Drive Capability: SSR > 10V DC into 500 Ω minimum.

Isolation: Not isolated from input or other SSR outputs.

Solid State

Operating Voltage Range: 20 - 280Vrms (47 - 63Hz)

Current Rating: 0.01 - 1A (full cycle rms on-state @ 25°C); derates linearly above 40°C to 0.5A @ 80°C.

Max. Non-repetitive Surge Current (16.6ms): 25A peak

Min. OFF-State $\frac{dv}{dt}$ @ Rated Voltage: 500V/ μ s

Max. OFF-State leakage @ Rated Voltage: 1 mA rms

Max. ON-State Voltage Drop @ Rated Current: 1.5V peak.

Repetitive Peak OFF-state Voltage, Vdrm: 600V minimum.

A.5 OUTPUT 2

General

Types Available: Relay, Dual Relay (with Output 4), SSR Drive and Solid State.

Relay

Contact Type: Single pole double throw (SPDT).

Rating: 2A resistive at 120/240V AC.

Lifetime: >500,000 operations at rated voltage/current.

Isolation: Inherent.

SSR Drive/TTL

Drive Capability: SSR >4.5V DC into 250 Ω minimum.

Isolation: Not isolated from input or other SSR outputs.

Dual Relay (Output 2 and Output 4)

Contact Type: Single pole single throw - normally open. Both relays share a single common terminal.

Rating: 2A resistive at 120/240V AC

Lifetime: >500,000 at rated voltage/current.

Isolation: Inherent.

Solid State

Operating Voltage Range: 20 - 280Vrms (47 - 63Hz)

Current Rating: 0.01 - 1A (full cycle rms on-state @ 25°C); derates linearly above 40°C to 0.5A @ 80°C.

Max. Non-repetitive Surge Current (16.6ms): 25A peak

Min. OFF-State $\frac{dv}{dt}$ @ Rated Voltage: 500V/ μ s

Max. OFF-State leakage @ Rated Voltage:	1 mA rms
Max. ON-State Voltage Drop @ Rated Current:	1.5V peak.
Repetitive Peak OFF-state Voltage, V _{drm} :	600V minimum.

A.6 OUTPUT 3

General

Types Available:	Relay or Solid State (Alarm only) or DC linear (Recorder Output only)
------------------	---

Relay

Contact Type:	Single pole double throw (SPDT).
Rating:	2A resistive at 120/240V AC.
Lifetime:	>500,000 operations at rated voltage/current.
Isolation:	Inherent.

Solid State

Operating Voltage Range:	20 - 280Vrms (47 - 63Hz)
Current Rating:	0.01 - 1A (full cycle rms on-state @ 25°C); derates linearly above 40°C to 0.5A @ 80°C.
Max. Non-repetitive Surge Current (16.6ms):	25A peak
Min. OFF-State $\frac{dv}{dt}$ @ Rated Voltage:	500V/ μ s
Max. OFF-State leakage @ Rated Voltage:	1 mA rms
Max. ON-State Voltage Drop @ Rated Current:	1.5V peak.
Repetitive Peak OFF-state Voltage, V _{drm} :	600V minimum.

DC

Resolution:	Eight bits in 250mS (10 bits in 1 second typical, >10 bits in >1 second typical).
Accuracy:	$\pm 0.25\%$ (mA at 250Ω , V at $2\text{ k}\Omega$). Degrades linearly to $\pm 0.5\%$ for increasing load burden (to limit as stated below).
Update Rate:	Every control algorithm execution.
Ranges:	0 - 20mA 4 - 20mA 0 - 5V 0 - 10V

(Changes between V and mA require link jumper movement.)

Load Impedance:	0 - 20mA: 500Ω maximum 4 - 20mA: 500Ω maximum 0 - 5V: 500Ω minimum 0 - 10V: 500Ω minimum
Isolation:	Isolated from all other inputs and outputs.
Range Selection Method:	Link jumper.

A.7 LOOP CONTROL

Automatic Tuning Types:	Pre-Tune and Self-Tune.
Proportional Bands:	0 (OFF), 0.5% - 999.9% of input span at 0.1% increments.
Reset (Integral Time Constant):	1s - 99min 59s and OFF
Rate (Derivative Time Constant):	0 (OFF) - 99 min 59 s.
Manual Reset (Bias):	Added each control algorithm execution. Adjustable in the range 0 - 100% of output power (single output) or -100% to +100% of output power (dual output).
Deadband/Overlap:	-20% to +20% of Proportional Band 1 + Proportional Band 2.
ON/OFF Differential:	0.1% to 10.0% of input span.

Auto/Manual Control:	User-selectable as either 0% primary power (Out Turnoff) or adjustable output power (Manual Control) with “bumpless” transfer.
Cycle Times:	Selectable from $\frac{1}{2}$ s to 512 secs in binary steps.
Setpoint Range:	Limited by Setpoint Maximum and Setpoint Minimum.
Setpoint Maximum:	Limited by Setpoint and Range Maximum.
Setpoint Minimum:	Limited by Range Minimum and Setpoint.
Setpoint Ramp:	Ramp rate selectable 1 - 9999 LSDs per hour and infinite. Number displayed is decimal-point-aligned with selected range.

A.8 SOFT START

Start-up Setpoint:	Bounded by Range Maximum and Range Minimum. Setpoint ramping is not applied during Soft Start.
Duration:	0 (Soft Start disabled) - 59 mins 45 secs in 15-second increments.
Time remaining:	Starts timing at instrument power-up in 1-second increments. Soft Start ends when time remaining equals zero.
Power Maximum:	Limits Output 1 power. Soft Start enabled: only limits during Soft Start. Soft Start disabled: limits at all times.
Output 1 Cycle Time:	Implicit. Cycle time used for Output 1 during Soft Start equals $\frac{1}{4}$ displayed value of Output 1 Cycle Time, but never less than 0.5 secs.
Operating Mode:	Assumes reverse-acting control.

A.9 PV ALARMS

Maximum Number of Alarms:	Two “soft” alarms.
Alarm Types:	Process high/low, deviation high/low, deviation band.
Max. No. of Outputs Available:	Up to three outputs can be utilised for alarm purposes.
Combinatorial Alarms:	Logical OR or AND of standard alarms to an individual hardware output is available.

A.10 HEATER BREAK ALARMS

Alarm Types:	Three dedicated “soft” alarms: Low, High and Short Circuit. Each can be disabled individually.
Alarm Trip Values:	Low/High alarms can be absolute Amps or percentage from nominal, adjustable. Short Circuit alarm is fixed at 5% of Heater High Scale Limit.
Nominal Heater Current:	Can be adjusted manually or, using Quick Transfer, automatically.
Quick Transfer:	One-shot procedure to read heater current and transfer read value to Heater Nominal Current value. Can be initiated locally from front panel or remotely via communications link or digital input.
Max. No. of Outputs Available:	Up to three outputs can be utilised for heater break alarms. Each output can be reverse-acting or direct-acting.
Combinatorial Alarms:	ORing of all enabled heater break alarms is implicit for any output used for heater break alarm.

A.11 PERFORMANCE

Reference Conditions

Generally as EN60546-1.

Ambient Temperature:	20°C ±2°C
Relative Humidity:	60 - 70%
Supply Voltage:	90 - 264V AC 50Hz (1%
Source Resistance:	<10Ω for thermocouple input
Lead Resistance:	<0.1Ω/lead balanced (Pt100)

Performance Under Reference Conditions

Common Mode Rejection:	>120dB at 50/60Hz giving negligible effect at up to 264V 50/60Hz.
Series Mode Rejection:	>500% of span (at 50/60Hz) causes negligible effect.

Thermocouple Inputs

Measurement Accuracy:	±0.25% of span ±1LSD.
Linearisation Accuracy:	Better than ±0.2°C any point, any 0.1°C range (±0.05°C typical). Better than ±0.5°C any point, any 1°C range.
Cold Junction Compensation:	Better than ±0.7°C.

RTD Inputs

Measurement Accuracy:	±0.25% of span ±1LSD
Linearisation Accuracy:	Better than ±0.2°C any point, any 0.1°C range (±0.05°C typical). Better than ±0.5°C any point, any 1°C range.

DC Output - Accuracy

Output 3 (Recorder Output):	±0.25% (mA @ 250Ω, V @ 2kΩ); Degrades linearly to ±0.5% for increasing burden (to specification limits).
-----------------------------	--

Operating Conditions

Ambient Temperature (Operating):	0°C to 55°C
Ambient Temperature (Storage):	-20°C to 80°C
Relative Humidity:	20% - 95% non-condensing
Supply Voltage:	90 - 264V AC 50/60Hz (standard) 20 - 50V AC 50/60Hz or 22 - 65V DC (option)
Source Resistance:	1000Ω maximum (thermocouple)
Lead Resistance:	50Ω per lead maximum balanced (Pt100)

Performance Under Operating Conditions

Temperature Stability:	0.01% of span/°C change in ambient temperature.
Cold Junction Compensation (thermocouple Only):	Better than $\pm 1^\circ\text{C}$.
Supply Voltage Influence:	Negligible.
Relative Humidity Influence:	Negligible
Sensor Resistance Influence:	Thermocouple 100Ω: <0.1% of span error Thermocouple 1000Ω: <0.5% of span error RTD Pt100 50Ω/lead: <0.5% of span error

A.12 COMMUNICATIONS

Type:	Serial asynchronous UART-to-UART link.
Presentation Layer:	MODBUS RTU or ASCII, selectable.
Data Format:	MODBUS RTU - One start bit, odd/even/no parity, eight-bit data one stop bit. ASCII - One start bit, even parity, seven-bit data, one stop bit.
Physical Layer:	RS485.

Transmitter Drive Capability:	32 standard RS485 unit loads
Receiver Bus Loading:	$\frac{1}{4}$ standard RS485 unit load
Baud rate:	Selectable from front panel to be 1200, 2400, 4800 or 9600 Baud.
Zone Address Select:	<p>MODBUS RTU: Selectable from front panel in the range 1 - 128 (standard RS485) or 1 - 255 (enhanced RS485) plus 0 (broadcast).</p> <p>ASCII: Selectable from front panel in the range 1 - 99 (for both standard RS485 and enhanced RS485).</p>

A.13 ENVIRONMENTAL

Operating Conditions:	See PERFORMANCE.
Approvals:	CE, UL pending, ULC pending.
EMI Susceptibility:	<p>Certified to EN50082-1:1992 and EN50082-2:1995.</p> <p>NOTE: For line-conducted disturbances induced by RF fields (10V 80% AM 1kHz), the product is self-recoverable in the frequency band 0.15 - 80MHz.</p>
EMI Emissions:	Certified to EN50081-1:1992 and EN50081-2:1994.
Safety Considerations:	Complies with EN61010-1:1993.
Supply Voltage:	<p>90 - 264V AC 50/60Hz (standard)</p> <p>20 - 50V AC 50/60Hz or 22 - 65V DC (option)</p>
Power Consumption:	4 watts approximately.
Front Panel Sealing:	To IP66 (similar to NEMA 4).

A.14 PHYSICAL

Dimensions:	Depth - 110mm
Front Panel:	<p>Width - 48mm, Height - 48mm ($\frac{1}{16}$-DIN)</p> <p>Width - 48mm, Height - 96mm ($\frac{1}{8}$-DIN)</p>

Mounting:	Plug-in with panel mounting sleeve. Panel cut-out 45mm x 45mm ($\frac{1}{16}$ -DIN) Panel Cutout 45mm x 92mm ($\frac{1}{8}$ -DIN)
Terminals:	Screw type (combination head).
Weight:	0.21kg maximum

ALPHABETICAL INDEX - VOLUME 2

A

AC/DC (24V) Supply Option	
Fuse rating	1-5
Terminal connections	1-5
Voltage range	1-5
Alarm 1 Type	
Selection of	3-6
Alarm 2 Type	
Selection of	3-7
Alarm Inhibit	
Description of operation	3-7
Selection of	3-7

C

Cold Junction Compensation	
Enabling/disabling	3-11
Cold Junction Compensation Disabled	
Indication of (Operator Mode)	3-11
Communications Address Range	
MODBUS RTU protocol	3-11
Communications Protocol	
Selection of	3-10
Configuration Mode	3-1
Automatic exit from	3-12
Entry into	3-1
Exit from	3-12
Controller Dimensions	A-12
Current Transformer	
Connections to	1-6

D

Dual Setpoint Selection	
TTL-Compatible Input	1-6
Voltage-Free Contacts	1-6
Dual Setpoint/Quick Transfer Option PCB	
Removal/replacement	2-3

H

Hardware Definition Code	
Adjustment of	3-3
Display of	3-2
Explanation of	3-3
Input/Output Type selection	3-3
Hardware Option Selection	3-2, 3-4
Heater Break Alarm Strategy	
Selection of	3-8
Heater Break Input Type	3-2
Selection of	3-5
Heater Current Input	
Terminal connections	1-6

I

Inhibiting Alarms	3-7
Input Connections	
Dual Setpoint Selection	1-6
RTD	1-6
Thermocouple	1-5
Input Range	
Selection of	3-5
Installation	1-1

L

Link Jumpers	
CPU PCB	2-3
DC Output 3 Option PCB	2-3
Lock Code	
Display of	3-12

M

Mains (Line) Supply	
Fuse rating	1-5
Terminal connections	1-5
Voltage range	1-5

O

Output 1 Action	
Selection of	3-6
Output 1 Type	
Selection of (link jumpers)	2-4
Output 2 Option PCB	
Removal/replacement	2-3
Output 2 Type	
Selection of	2-5
Output 2 Usage	
Selection of	3-8
Output 3 Option PCB	
Removal/replacement	2-3
Output 3 Type	
Selection of	2-5
Output 3 Usage	
Selection of	3-9
Output 4 Usage	
As Heater Break Alarm output	3-10
Output Connections	
DC	1-7
Relay	1-7
SSR Drive	1-7

P

Panel-Mounting	
Controller dimensions	1-1
Cut-out dimensions (multiple installation)	1-1
Cut-out dimensions (single installation)	1-1
Maximum panel thickness	1-1

Panel-mounting the Controller	1-1
Product Specification	A-1

Q

Quick Transfer Selection Input	
Terminal connections	1-6
Quick Transfer/Dual Setpoint Option PCB	
Removal/replacement	2-3

R

Range	
See Input Range	
Rear Terminal Connections	1-3
Remote Heater Current Transfer Input	
Terminal connections	1-6
Remote Heater Transfer Option PCB	
Removal/replacement	2-3
Removing the Controller from its Housing	2-1
Replacing the Controller in its Housing	2-4
RS485 Communications Option PCB	
Removal/replacement	2-3

S

Sensor Break	
Effect on outputs (RTD inputs)	A-2
Effect on outputs (thermocouple inputs)	A-2
Serial Communications	
Address, selection of	3-11
Baud rate, selection of	3-10
Serial Communications Connections	1-7
"A" terminal	1-7
"B" terminal	1-7

U

Unpacking Procedure	1-1
---------------------	-----